

Service Manual

Room Air Conditioner

CS-W7CKP CU-W7CKP5
 CS-W9CKP CU-W9CKP5
 CS-W12CKP CU-W12CKP5



⚠ WARNING

This service information is designed for experienced repair technicians only and is not designed for use by the general public. It does not contain warnings or cautions to advise non-technical individuals of potential dangers in attempting to service a product. Products powered by electricity should be serviced or repaired only by experienced professional technicians. Any attempt to service or repair the product or products dealt with in this service information by anyone else could result in serious injury or death.

⚠ PRECAUTION OF LOW TEMPERATURE

In order to avoid frostbite, be assured of no refrigerant leakage during the installation or repairing of refrigeration circuit.

CONTENTS

	Page		Page
1 Features	2	11 Installation and Servicing Air Conditioner Using R410A	54
2 Functions	3	12 Servicing Information	65
3 Product Specifications	6	13 Troubleshooting Guide	69
4 Dimensions	12	14 Technical Data	71
5 Refrigeration Cycle Diagram	14	15 Exploded View	76
6 Block Diagram	15	16 Replacement Parts List	77
7 Wiring Diagram	16	17 Exploded View	78
8 Operation Details	17	18 Replacement Parts List	79
9 Operating Instructions	39	19 Electronic Circuit Diagram	80
10 Installation Instructions	44		

Panasonic

© 2002 Matsushita Industrial Corp. Sdn. Bhd. (11969-T). All rights reserved. Unauthorized copying and distribution is a violation of law.

1 Features

- **High Efficiency**
- **Compact Design**
- **Comfort Environment**
 - Ionizer control for generate negative ion in discharge air
 - Air filter with function to reduce dust and smoke
 - Wider range of horizontal discharge air
- **Auto Restart**
 - Random auto restart after power failure for safety restart operation
- **Removable and Washable Front Panel**
- **Remote Control Self-illuminating Button**
- **Catechin Air Purifying Filter**
 - Trap dust, tobacco smoke and tiny particles
 - Prevent the growth of bacteria and viruses trapped
- **Triple Deodorizing Filter**
 - Absorb odours produced by wall paper, construction material and living environment
- **Quality Improvement**
 - Gas leakage protection
 - Prevent compressor reverse cycle
 - 2-stage OLP to protect compressor
 - Noise prevention during soft dry operation.
 - Compressor Protection Control (Cooling & Soft Dry)
 - Overload Protection Control (Heating)
 - Outdoor Fan Control
 - Compressor High Pressure Control
 - Blue Coated Condenser
 - High resistance to corrosion.
- **Operation Improvement**
 - Quiet mode to provide extra quiet operation
 - Powerful mode to reach the desired room temperature quickly
- **Long Installation Piping**
 - CS/CU-W7CK, CS/CU-W9CK, long piping up to 10 meter
 - CS/CU-W12CK, long piping up to 15 meter
- **24-hour Timer Setting**
- **Environmental Friendly**
 - R410A, which does not contain chlorine, is used as its refrigerant, so there is no danger of damage to the ozone layer in Stratosphere.

2 Functions

Remote Control

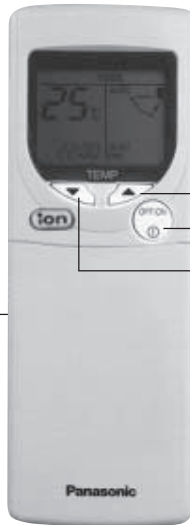

Self illuminating button

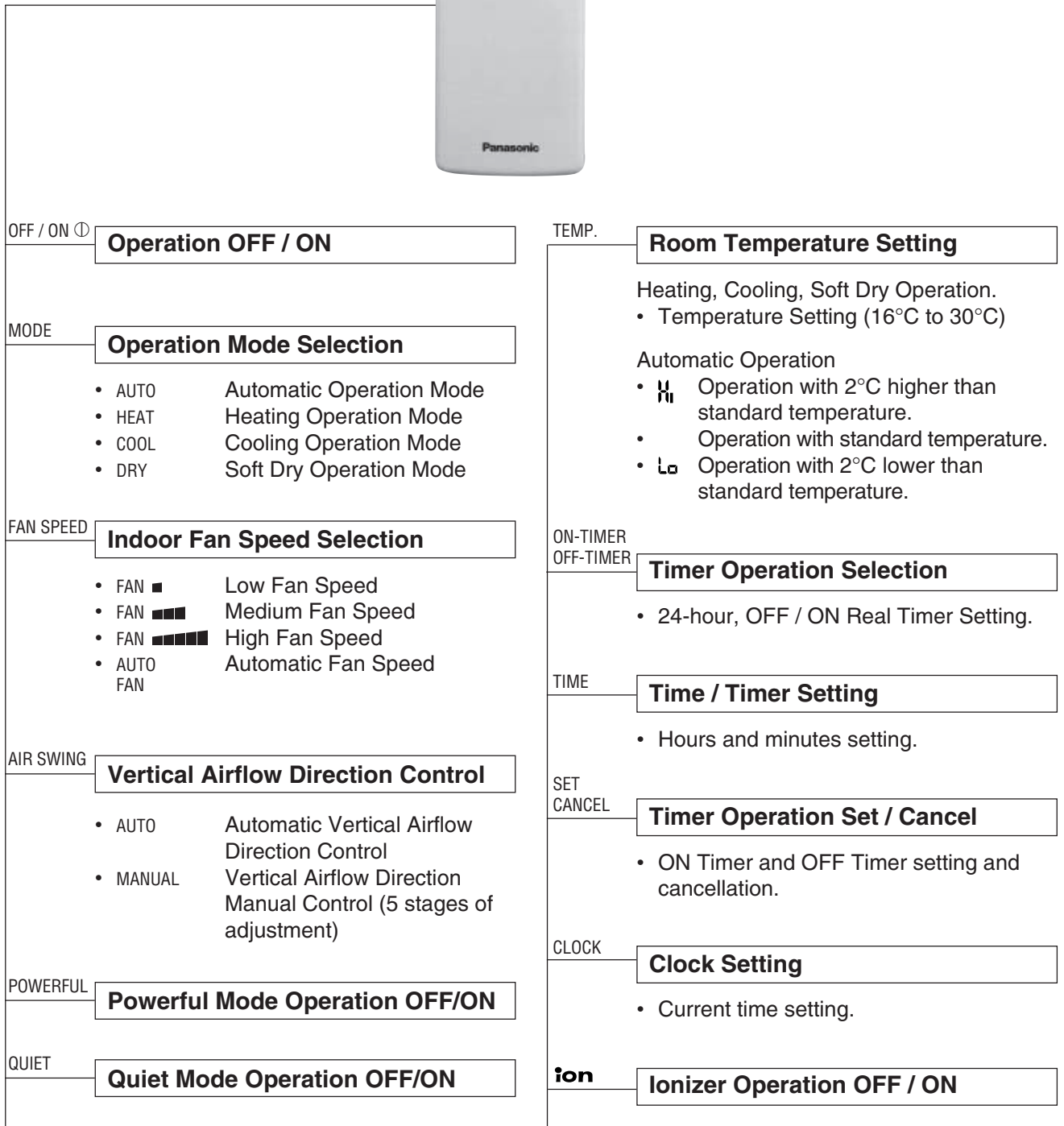

Indoor Unit



AUTO
OFF / ON

Automatic Operation Button

- Press for < 5s to operate Automatic operation mode.
(Used when the remote control cannot be used.)
- Press continuously for 5s or < 10s to operate Test Run/Pump down. "Beep" sound will be heard at the 5th second.
(Used when test running or servicing.)
- Press continuously for 10s and above to omit or resume the remote control signal receiving sound. "Beep, beep" sound will be heard at the 10th second.

Operation Indication Lamps (LED)

- POWER (Green) Lights up in operation, blinks in Automatic Operation Mode judging.
- QUIET (Orange) Lights up in Quiet Mode Operation.
- TIMER (Orange) Lights up in Timer Setting.
- POWERFUL (Orange) ... Lights up in Powerful Mode Operation.
- **ion** (Green) Lights up in Ionizer Mode Operation.

Operation Mode

- Heating, Cooling, Soft Dry and Automatic Mode.

Powerful Operation

- Reaches the desired room temperature quickly.

Quiet Operation

- To provide extra quiet operation.

Random Auto Restart Control

- Operation is restarted randomly after power failure at previous setting mode.

Anti-Freezing Control

- Anti-Freezing control for indoor heat exchanger. (Cooling and Soft Dry)

Ionizer Control

- Ionizer control for generate negative ion in discharge air.

Indoor Fan Speed Control

- High, Medium and Low.
- Automatic Fan Speed Mode
 - Heating : Fan speed varies from Me → SLo in accordance with indoor heat exchanger.
 - Cooling : Fan rotates at Hi, Me and SLo speed. Deodorizing control is available.
 - Soft Dry : Fan rotates at Lo- speed. Deodorizing control is available.

Airflow Direction Control

- Automatic air swing and manual adjusted by remote control for vertical airflow.
- Manually adjusted by hand for horizontal airflow.

Starting Current Control

- Fan motor is delayed for 1.6 seconds when compressor starts simultaneously.

Time Delay Safety Control

- Restarting is inhibited for approx. 3 minutes.

7 Minutes Time Save Control

- Cooling Operation only.

30 Minutes Time Save Control

- Heating Operation only.

Hot-Start Control

- At Heating Operation the indoor fan will operate at SLo speed when indoor heat exchanger temperature reaches 30°C.

Anti Cold Draft Control

- The indoor fan operates at SLo when the indoor heat exchanger temperature is low. (During Heating mode thermal off)

Outdoor Unit



Compressor Reverse Rotation Protection Control

- To protect compressor from reverse rotation when there is a instantaneous power failure.

Overload Protector

- 2-Stage OLP to protect the compressor. Overload Protector will trip when
 - Temperature of compressor increases to 120°C.
 - High temperature or high current flows to compressor. (Refer circuit diagram for OLP characteristic)

60 Secs. Forced Operation Control

- Once the compressor is activated, it does not stop within the first 60 secs. However, it stops immediately with remote control stop signal.

Outdoor Fan Operation Control

- Temperature Fuse.

Deice Control

- To prevent frosting at outdoor heat exchanger. (Only for Heating Operation)
- Temperature of outdoor heat exchanger is sensed by TRS (Thermal Reed Switch). TRS OFF temperature 4°C. TRS ON temperature -3°C.

Overload Protection Control

- Outdoor fan stops when indoor heat exchanger temperature rises to 51°C and above, and restarts when the indoor heat exchanger temperature drops to 49°C and below.
- Compressor stop when indoor heat exchanger temperature reaches 65°C or above. (Heating Operation Only)



Compressor Protection Control

- If the outdoor fan motor is not running after compressor starts for 50 secs., compressor will stop. (Cooling and Soft Dry Operation only).

4-Way Valve Control

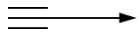

- When the unit is switched to "OFF" during Heating Operation, 4-way valve stays at Heating position for 5 minutes.

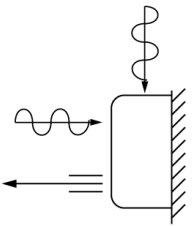
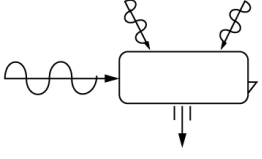
3 Product Specifications

		Unit	CS-W7CKP	CU-W7CKP5
Cooling Capacity		kW (kcal/h)	2.38 (2,050)	
		BTU/h	8,120	
Heating Capacity		kW (kcal/h)	2.45 (2,110)	
		BTU/h	8,350	
Moisture Removal		l/h (Pint/h)	1.5 (3.2)	
Power Source		Phase	Single	
		V	230	
		Cycle	50	
Airflow Method		<p>OUTLET</p>  <p>INTAKE</p> 	<p>SIDE VIEW</p> 	<p>TOP VIEW</p> 
Air Volume	Indoor Air (Lo)	m ³ /min (cfm)	Cooling; 6.4 (230) Heating; 7.0 (250)	—
	Indoor Air (Me)	m ³ /min (cfm)	Cooling; 7.6 (270) Heating; 7.7 (270)	—
	Indoor Air (Hi)	m ³ /min (cfm)	Cooling; 8.5 (300) Heating; 9.9 (350)	Cooling; 34.5 (1,220)
	Indoor Air (SHi)	m ³ /min (cfm)	Cooling; 9.9 (350) Heating; 9.9 (350)	—
Noise Level		dB (A)	Cooling; High 34, Low 26 Heating; High 36, Low 26	Cooling; High 46 Heating; High 48
		Power level dB	Cooling; High 47 Heating; High 49	Cooling; High 61 Heating; High 63
Electrical Data	Input	W	Cooling; 660 Heating; 595	
	Running Current	A	Cooling; 3.0 Heating; 2.7	
	EER	W/W (BTU/hW)	Cooling; 3.61 (12.3)	
	COP	W/W (BTU/hW)	Heating; 4.12 (14.0)	
	Starting Current	A	12.5	
Piping Connection Port (Flare piping)		inch inch	G ; Half Union 3/8" L ; Half Union 1/4"	G ; 3-way valve 3/8" L ; 2-way valve 1/4"
Pipe Size (Flare piping)		inch inch	G ; (gas side) 3/8" L ; (liquid side) 1/4"	G ; (gas side) 3/8" L ; (liquid side) 1/4"
Drain Hose	Inner diameter	mm	12	—
	Length	mm	650	—
Power Cord Length		m	1.9	—
Number of core-wire			3 (1.0 mm ²)	—

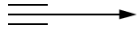

		Unit	CS-W7CKP	CU-W7CKP5	
Dimensions	Height	inch (mm)	10 - 13/16 (275)	21 - 1/4 (540)	
	Width	inch (mm)	31 - 15/32 (799)	30 - 23/32 (780)	
	Depth	inch (mm)	8 - 9/32 (210)	11 - 3/8 (289)	
Net Weight		lb (kg)	20 (9.0)	71 (32)	
Compressor	Type		—	Rotary (1 cylinder) rolling piston type	
	Motor Type		—	Induction (2-poles)	
	Rated Output	W	—	670	
Air Circulation	Type		Cross-flow Fan	Propeller Fan	
	Material		AS + Glass Fiber 20%	PP Resin	
	Motor Type		Induction (4-poles)	Induction (6-poles)	
	Input	W	49.2	63.0	
	Rated Output	W	15	29	
	Fan Speed	Low	rpm	Cooling; 780	—
				Heating; 840	—
		Medium	rpm	Cooling; 920	—
High		rpm	Cooling; 1,030	820	
SuperHigh	rpm	Cooling; 1,190	—		
Heating; 1,190					
Heat Exchanger	Description		Evaporator	Condenser	
	Tube material		Copper	Copper	
	Fin material		Aluminium (Pre Coat)	Aluminium (Blue Coat)	
	Fin Type		Slit Fin	Corrugate Fin	
	Row / Stage		(Plate fin configuration, forced draft)		
			2 x 15	1 x 20	
	FPI		21	17	
Size (W x H x L)	mm	610 x 315 x 25.4	841 x 508 x 22		
Refrigerant Control Device			—	Capillary Tube	
Refrigeration Oil		(cm ³)	—	FVC68D (330)	
Refrigerant (R-410A)		g (oz)	—	970 (34.2)	
Thermostat			Electronic Control	—	
Protection Device			—	Overload Protector	
Capillary Tube	Length	mm	—	Cooling; 970, Heating; 610	
	Flow Rate	l/min	—	Cooling; 5.0, Heating; 6.5	
	Inner Diameter	mm	—	Cooling; 1.2, Heating; 1.2	
Air Filter	Material Style		P.P. Honeycomb	—	
Capacity Control			Capillary Tube		
Compressor Capacitor		μF, VAC	—	25 μF, 370VAC	
Fan Motor Capacitor		μF, VAC	1.5 μF, 400VAC	2.0 μF, 450VAC	

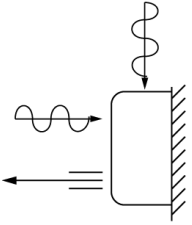
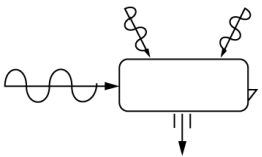
- Specifications are subject to change without notice for further improvement.

		Unit	CS-W9CKP	CU-W9CKP5
Cooling Capacity		kW (kcal/h)	2.90 (2,490)	
		BTU/h	9,890	
Heating Capacity		kW (kcal/h)	3.14 (2,700)	
		BTU/h	10,700	
Moisture Removal		l/h (Pint/h)	1.7 (3.6)	
Power Source		Phase	Single	
		V	230	
		Cycle	50	
Airflow Method		OUTLET  INTAKE 	SIDE VIEW 	TOP VIEW 
Air Volume	Indoor Air (Lo)	m ³ /min (cfm)	Cooling; 6.8 (240) Heating; 7.0 (250)	—
	Indoor Air (Me)	m ³ /min (cfm)	Cooling; 8.3 (290) Heating; 8.0 (280)	—
	Indoor Air (Hi)	m ³ /min (cfm)	Cooling; 9.9 (350) Heating; 10.2 (360)	Cooling; 34.5 (1,220)
	Indoor Air (SHi)	m ³ /min (cfm)	Cooling; 10.2 (360) Heating; 10.2 (360)	—
Noise Level		dB (A)	Cooling; High 36, Low 26 Heating; High 39, Low 26	Cooling; High 48 Heating; High 49
		Power level (dB)	Cooling; High 49 Heating; High 52	Cooling; High 63 Heating; High 64
Electrical Data	Input	W	Cooling; 850 Heating; 780	
	Running Current	A	Cooling; 3.7 Heating; 3.5	
	EER	W/W (BTU/hW)	Cooling; 3.41 (11.6)	
	COP	W/W (BTU/hW)	Heating; 4.03 (13.7)	
	Starting Current	A	15.9	
Piping Connection Port (Flare piping)		inch inch	G ; Half Union 3/8" L ; Half Union 1/4"	G ; 3-way valve 3/8" L ; 2-way valve 1/4"
Pipe Size (Flare piping)		inch inch	G ; (gas side) 3/8" L ; (liquid side) 1/4"	G ; (gas side) 3/8" L ; (liquid side) 1/4"
Drain Hose	Inner diameter	mm	12	
	Length	mm	650	
Power Cord Length Number of core-wire		m	1.9 3 (1.0 mm ²)	
Dimensions	Height	inch (mm)	10 - 13/16 (275)	
	Width	inch (mm)	31 - 15/32 (799)	
	Depth	inch (mm)	8 - 9/32 (210)	
			11 - 3/8 (289)	

		Unit	CS-W9CKP	CU-W9CKP5	
Net Weight		lb (kg)	20 (9.0)	73 (33)	
Compressor	Type		—	Rotary (1 cylinder) rolling piston type	
	Motor Type		—	Induction (2-poles)	
	Rated Output	W	—	780	
Air Circulation	Type		Cross-flow Fan	Propeller Fan	
	Material		AS + Glass Fiber 20%	PP Resin	
	Motor Type		Induction (4-poles)	Induction (6-poles)	
	Input	W	49.2	63.0	
	Rated Output	W	15	29	
	Fan Speed	Low	rpm	Cooling; 780 Heating; 840	—
		Medium	rpm	Cooling; 960 Heating; 960	—
		High	rpm	Cooling; 1,140 Heating; 1,230	820
SuperHigh		rpm	Cooling; 1,230 Heating; 1,230	—	
Heat Exchanger	Description		Evaporator	Condenser	
	Tube material		Copper	Copper	
	Fin material		Aluminium (Pre Coat)	Aluminium (Blue Coat)	
	Fin Type		Slit Fin	Corrugate Fin	
	Row / Stage		(Plate fin configuration, forced draft) 2 x 15	1 x 20	
	FPI		21	17	
	Size (W x H x L)	mm	610 x 315 x 25.4	841 x 508 x 22	
Refrigerant Control Device			—	Capillary Tube	
Refrigeration Oil		(cm ³)	—	FVC68D (330)	
Refrigerant (R-410A)		g (oz)	—	940 (33.2)	
Thermostat			Electronic Control	—	
Protection Device			—	Overload Protector	
Capillary Tube	Length	mm	—	Cooling; 970, Heating; 720	
	Flow Rate	l/min	—	Cooling; 5.0, Heating; 7.5	
	Inner Diameter	mm	—	Cooling; 1.2, Heating; 1.3	
Air Filter	Material Style		P.P. Honeycomb	—	
Capacity Control			Capillary Tube		
Compressor Capacitor		µF, VAC	—	30 µF, 370VAC	
Fan Motor Capacitor		µF, VAC	1.5 µF, 400VAC	2.0 µF, 450VAC	

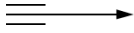
- Specifications are subject to change without notice for further improvement.

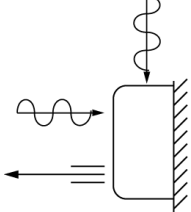
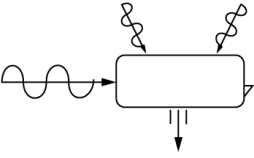
		Unit	CS-W12CKP	CU-W12CKP5
Cooling Capacity		kW (kcal/h)	3.74 (3,220)	
		BTU/h	12,800	
Heating Capacity		kW (kcal/h)	4.09 (3,520)	
		BTU/h	14,000	
Moisture Removal		l/h (Pint/h)	2.2 (4.6)	
Power Source		Phase	Single	
		V	230	
		Cycle	50	
Airflow Method		OUTLET  INTAKE 	SIDE VIEW 	TOP VIEW 
Air Volume	Indoor Air (Lo)	m ³ /min (cfm)	Cooling; 7.3 (260) Heating; 7.8 (270)	—
	Indoor Air (Me)	m ³ /min (cfm)	Cooling; 9.1 (320) Heating; 9.1 (320)	—
	Indoor Air (Hi)	m ³ /min (cfm)	Cooling; 10.2 (360) Heating; 10.6 (370)	Cooling; 33.0 (1,160)
	Indoor Air (SHi)	m ³ /min (cfm)	Cooling; 10.6 (370) Heating; 10.6 (370)	—
Noise Level		dB (A)	Cooling; High 39, Low 29 Heating; High 40, Low 29	Cooling; High 49 Heating; High 49
		Power level (dB)	Cooling; High 52 Heating; High 53	Cooling; High 64 Heating; High 65
Electrical Data	Input	kW	Cooling; 1.10 Heating; 1.07	
	Running Current	A	Cooling; 4.9 Heating; 4.8	
	EER	W/W (BTU/hW)	Cooling; 3.40 (11.6)	
	COP	W/W (BTU/hW)	Heating; 3.82 (13.1)	
	Starting Current	A	17.8	
Piping Connection Port (Flare piping)		inch inch	G ; Half Union 1/2" L ; Half Union 1/4"	G ; 3-way valve 1/2" L ; 2-way valve 1/4"
Pipe Size (Flare piping)		inch inch	G ; (gas side) 1/2" L ; (liquid side) 1/4"	G ; (gas side) 1/2" L ; (liquid side) 1/4"
Drain Hose	Inner diameter	mm	12	—
	Length	mm	650	—
Power Cord Length		m	1.9	—
Number of core-wire			3 (1.0 mm ²)	—
Dimensions	Height	inch (mm)	10 - 13/16 (275)	21 - 1/4 (540)
	Width	inch (mm)	31 - 15/32 (799)	30 - 23/32 (780)
	Depth	inch (mm)	8 - 9/32 (210)	11 - 3/8 (289)

		Unit	CS-W12CKP	CU-W12CKP5	
Net Weight		lb (kg)	20 (9.0)	77 (35)	
Compressor	Type		—	Rotary (1 cylinder) rolling piston type	
	Motor Type		—	Induction (2-poles)	
	Rated Output	W	—	830	
Air Circulation	Type		Cross-flow Fan	Propeller Fan	
	Material		AS + Glass Fiber 20%	PP Resin	
	Motor Type		Induction (4-poles)	Induction (6-poles)	
	Input	W	49.2	67.4	
	Rated Output	W	15	33	
	Fan Speed	Low	rpm	Cooling; 900 Heating; 960	—
		Medium	rpm	Cooling; 1,120 Heating; 1,120	—
		High	rpm	Cooling; 1,260 Heating; 1,300	845
SuperHigh		rpm	Cooling; 1,300 Heating; 1,300	—	
Heat Exchanger	Description		Evaporator	Condenser	
	Tube material		Copper	Copper	
	Fin material		Aluminium (Pre Coat)	Aluminium (Blue Coat)	
	Fin Type		Slit Fin	Corrugate Fin	
	Row / Stage		(Plate fin configuration, forced draft)		
			2 × 15	2 × 24	
	FPI		21	17	
Size (W × H × L)	mm	610 × 315 × 25.4	705.8 × 504 × 18.9 735.1		
Refrigerant Control Device			—	Capillary Tube	
Refrigeration Oil		(cm ³)	—	FVC68D (330)	
Refrigerant (R-410A)		g (oz)	—	1,060 (37.4)	
Thermostat			Electronic Control	—	
Protection Device			—	Overload Protector	
Capillary Tube	Length	mm	—	Cooling; 970, Heating; 590	
	Flow Rate	l/min	—	Cooling; 5.0, Heating; 8.2	
	Inner Diameter	mm	—	Cooling; 1.2, Heating; 1.3	
Air Filter	Material		P.P.	—	
	Style		Honeycomb		
Capacity Control			Capillary Tube		
Compressor Capacitor		μF, VAC	—	35 μF, 370VAC	
Fan Motor Capacitor		μF, VAC	1.5 μF, 400VAC	2.0 μF, 450VAC	

- Specifications are subject to change without notice for further improvement.

4 Dimensions

CS-W7CK / CS-W9CK / CS-W12CK

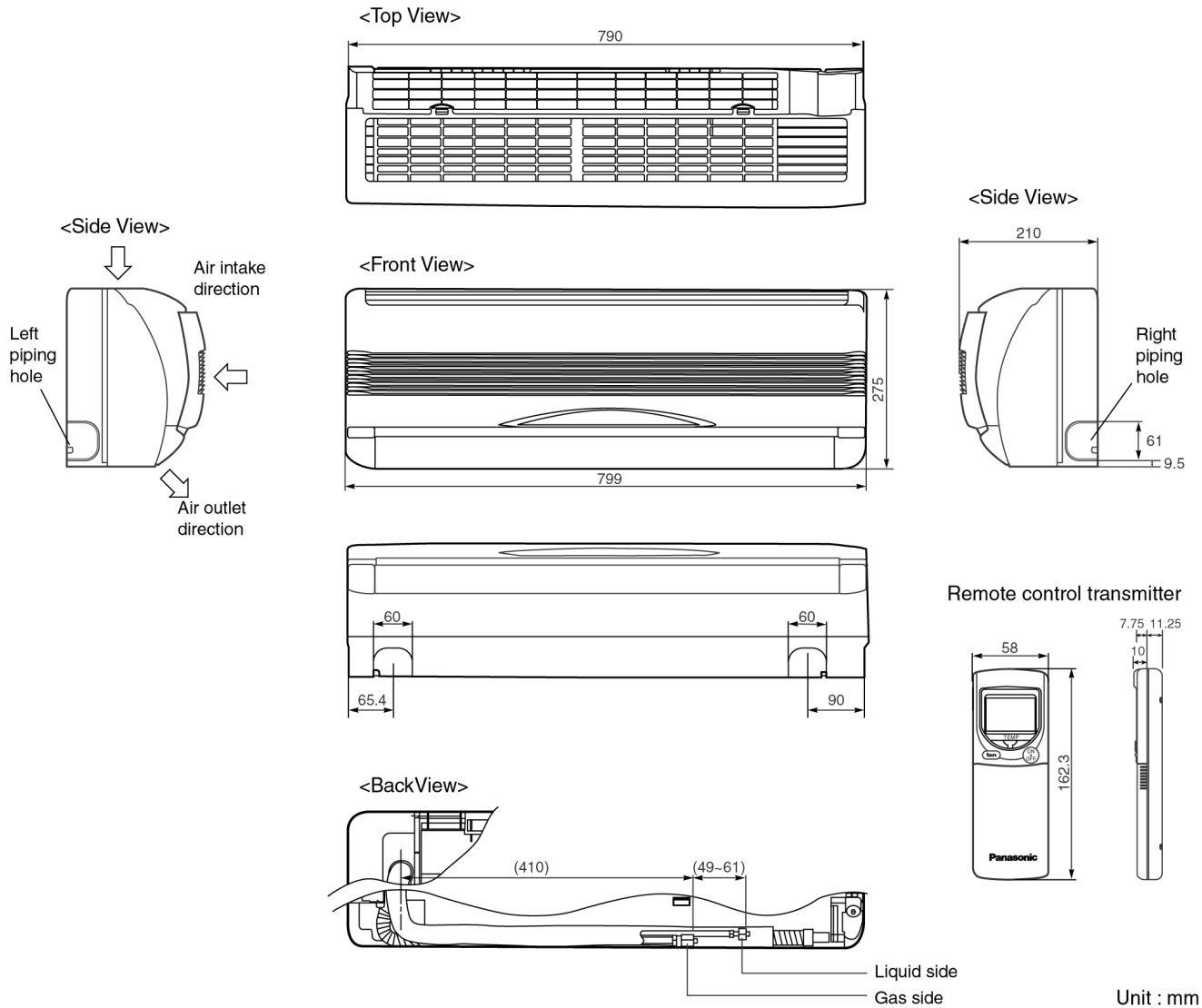

Relative position between the indoor unit and the installation plate <Front View>

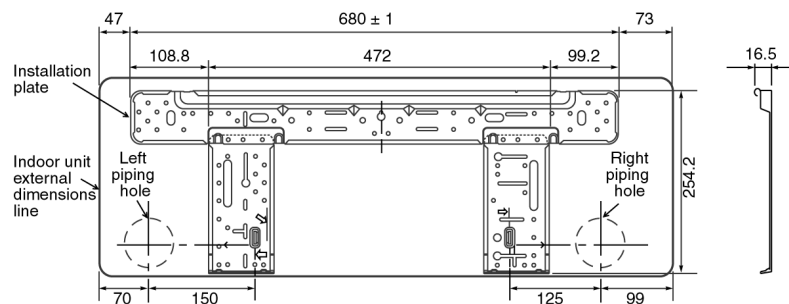

CU-W7CK / CU-W9CK / CU-W12CK

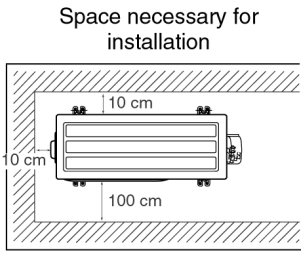

Anchor Bolt Pitch
320 x 570

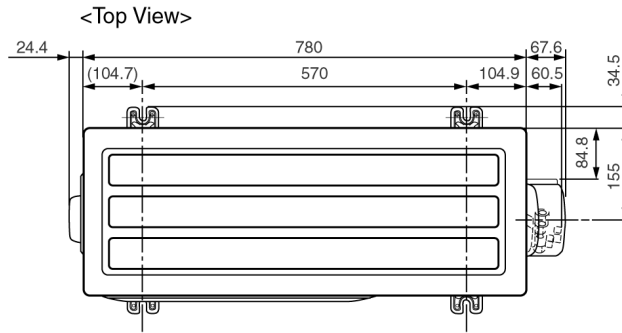

2-way valve at Liquid side
(High Pressure)

3-way valve at Gas side
(Low Pressure)

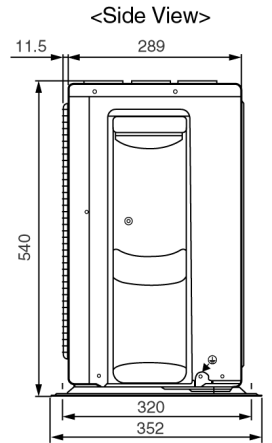
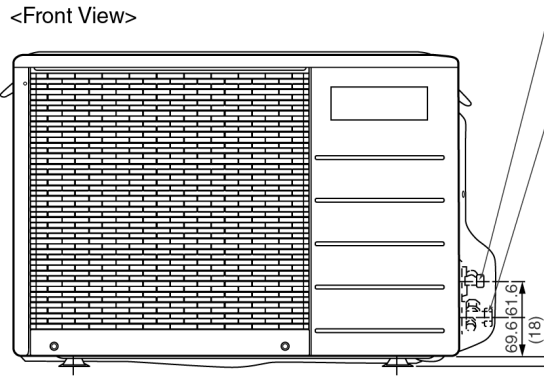
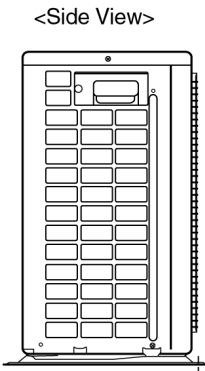

5 Refrigeration Cycle Diagram

CS-W7CK / CU-W7CK
 CS-W9CK / CU-W9CK
 CS-W12CK / CU-W12CK

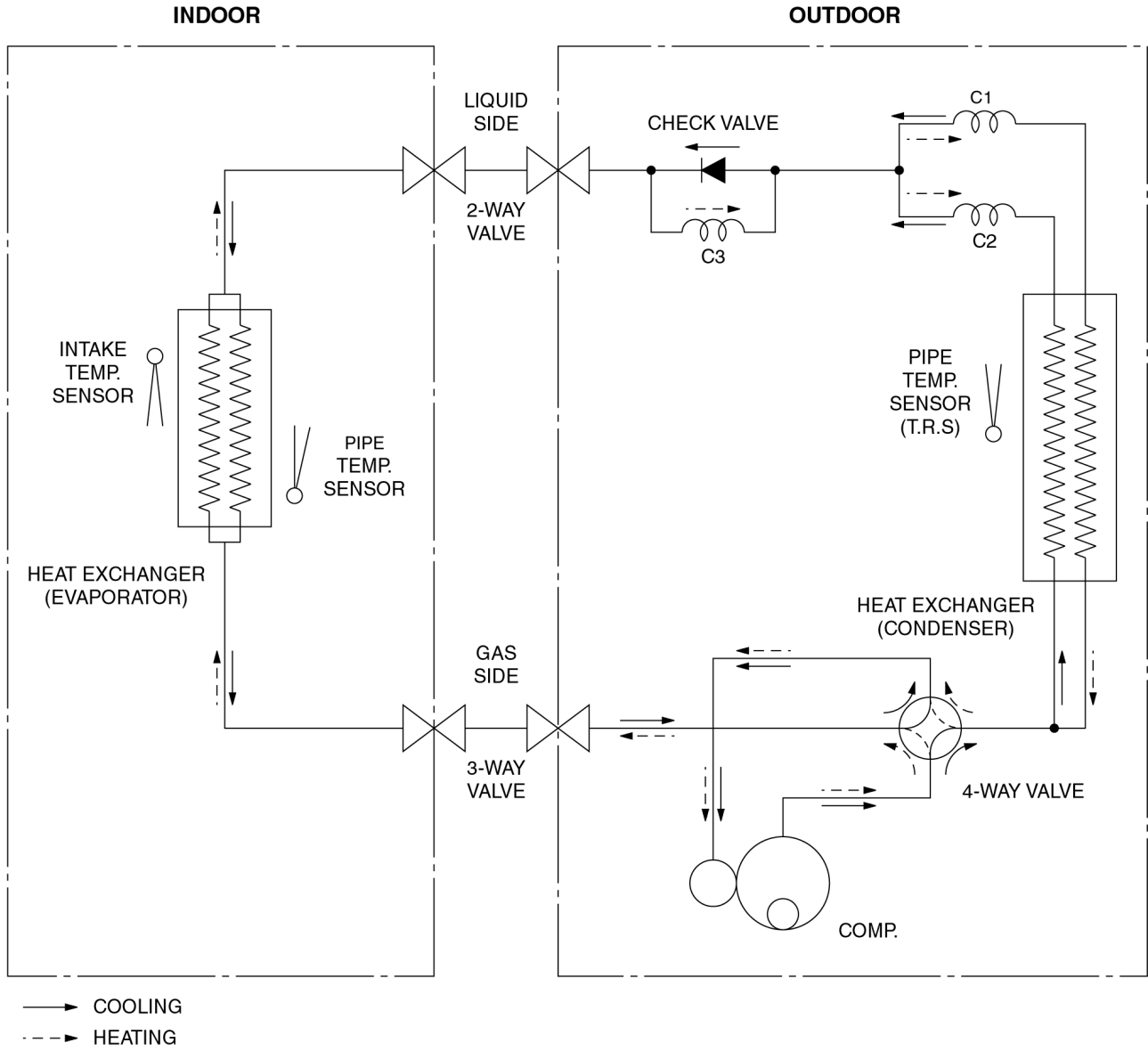

6 Block Diagram

CS-W7CK / CU-W7CK
 CS-W9CK / CU-W9CK
 CS-W12CK / CU-W12CK

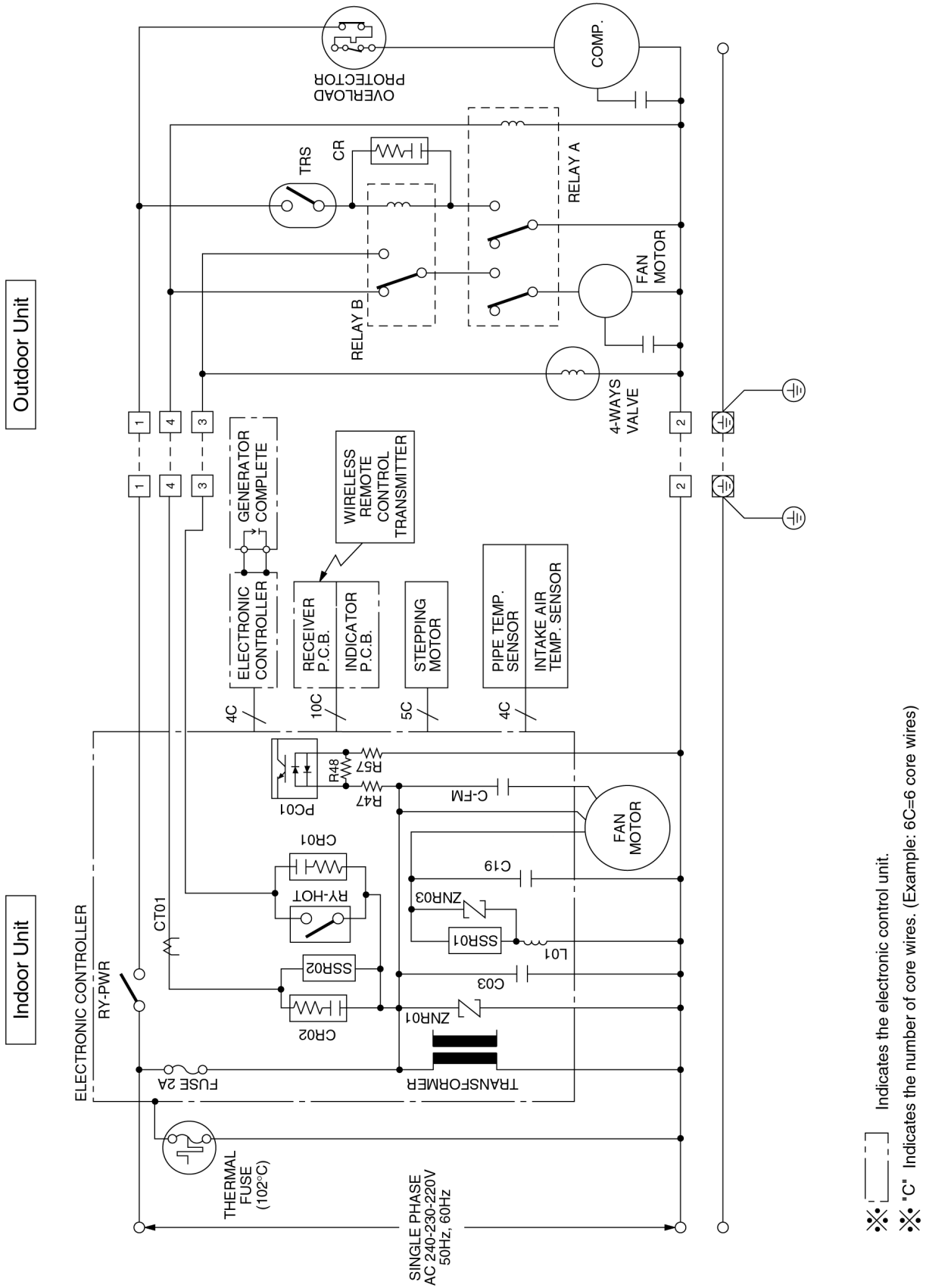

⊞ Indicates the electronic control unit.
 ⊞ "C" Indicates the number of core wires. (Example: 6C=6 core wires)

7 Wiring Diagram

CS-W7CK / CU-W7CK
CS-W9CK / CU-W9CK
CS-W12CK / CU-W12CK

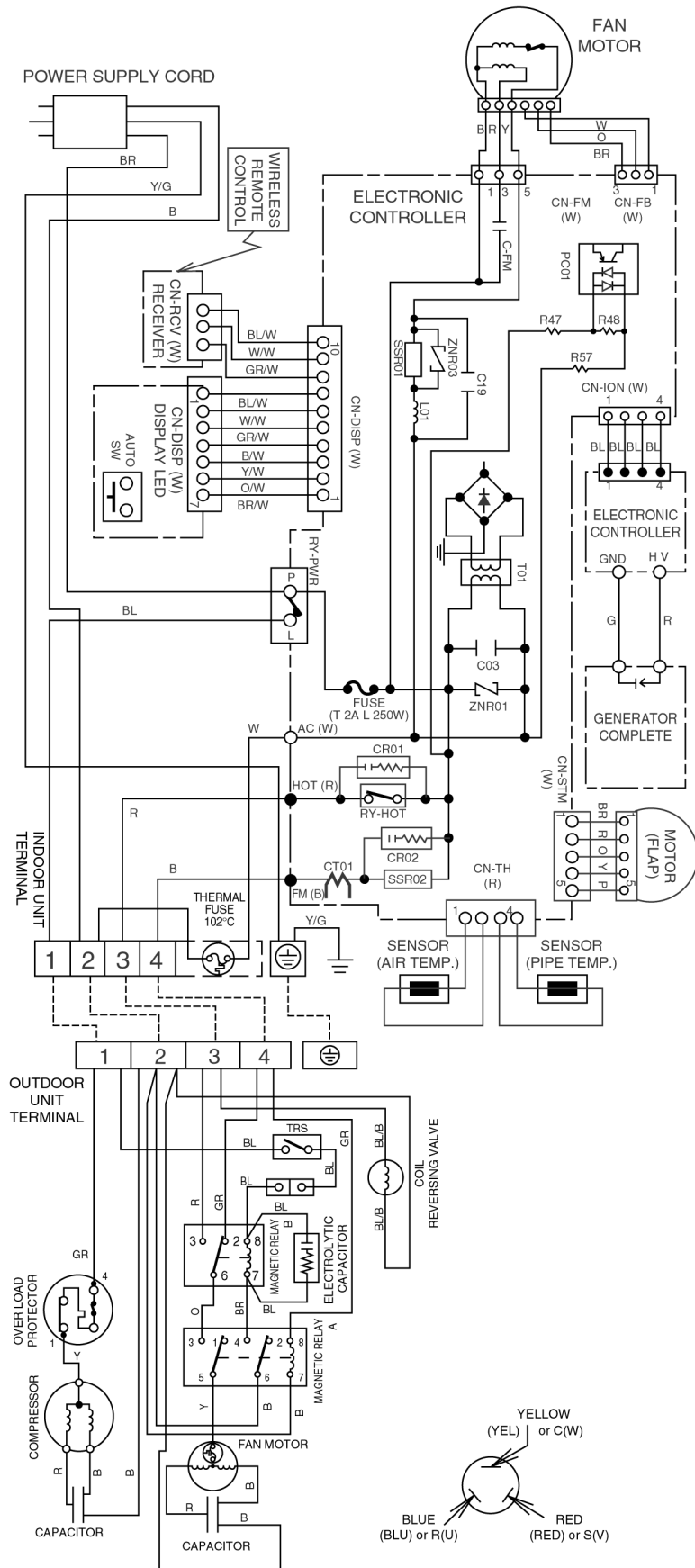

Remarks:

- B : BLUE
- BR : BROWN
- BL : BLACK
- GR : GRAY
- O : ORANGE
- P : PINK
- R : RED
- W : WHITE
- Y/G : YELLOW / GREEN

Resistance of Indoor Fan Motor Windings

MODEL	CS-W7CKP CS-W9CKP CS-W12CKP
CONNECTION	CWA921060
BLUE - YELLOW	371.0 Ω
YELLOW - RED	386.6 Ω

Note: Resistance at 20°C of ambient temperature.

Resistance of Outdoor Fan Motor Windings

MODEL	CU-W7CKP5 CU-W9CKP5	CU-W12CKP5
CONNECTION	CWA951119	CWA951121
BLUE - YELLOW	302.3 Ω	200.4 Ω
YELLOW - RED	267.8 Ω	252.5 Ω

Note: Resistance at 26°C of ambient temperature.

Resistance of Compressor Windings

MODEL	CU-W7CKP5
CONNECTION	GB080PAA
C - R	4.96 Ω
C - S	4.67 Ω

Note: Resistance at 25°C of ambient temperature.

MODEL	CU-W9CKP5
CONNECTION	GB102PAA
C - R	3.77 Ω
C - S	4.02 Ω

Note: Resistance at 25°C of ambient temperature.

MODEL	CU-W12CKP5
CONNECTION	GB134PAA
C - R (Main)	3.27 Ω
C - S (Sub)	3.02 Ω

Note: Resistance at 25°C of ambient temperature.

8 Operation Details

8.1. Cooling Mode Operation

Cooling in operation according to Remote Control setting.

Time Delay Safety Control (3 minutes)

- When the compressor is stopped by Remote Control, it restarts after 3 minutes when it is turned ON by Remote Control.
- When the setting temperature is reached during cooling operation, the compressor stops and it will not start for 3 minutes.

7 minutes Time Save Control

- The compressor will start automatically if it has stopped for 7 minutes even if the room temperature is between the compressor ON temperature and OFF temperature.

Starting Current Control

- When the compressor outdoor fan motor and indoor fan motor are simultaneously started, the indoor fan motor will operate 1.6 second later.

Anti-Freezing Control

- If the temperature of the indoor heat exchanger falls continuously below 2°C for 4 minutes or more, the compressor turns off to protect the indoor heat exchanger from freezing. The fan speed setting remains the same.
- Compressor will restart again when the indoor heat exchanger temperature rises to 10°C (Recovery).

⊗ 3 minutes waiting of Time Delay Safety Control is valid for Cooling Operation.

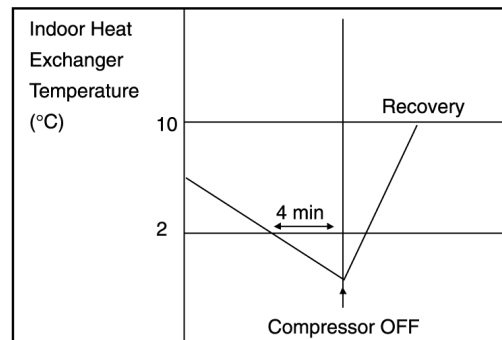

Compressor Reverse Rotation Protection Control

- If the compressor is operating continuously for 5 minutes or longer and the temperature difference between intake air and indoor heat exchanger is 2.5°C or less for 2 minutes, compressor will stop and restart automatically. (Time Delay Safety Control is valid)

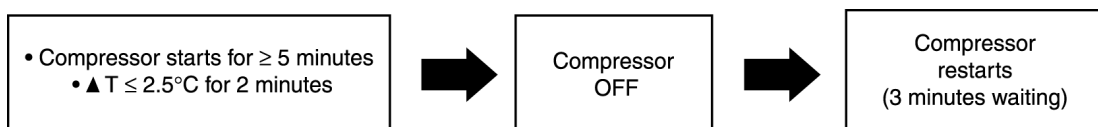

▲ T = Intake air temperature - Indoor heat exchanger temperature

This is to protect reverse rotation of the compressor when there is a instantaneous power failure.

Compressor Protection Control

- After the compressor starts for 50 seconds but the outdoor fan motor is still OFF, the compressor will stop and restart automatically. (Time Delay Safety Control is valid).

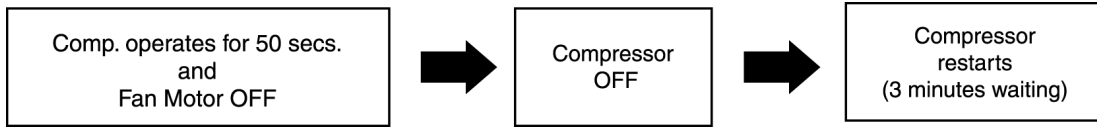

- If the above phenomenon is repeated for 3 times, the compressor will stop totally.
- The above phenomenon is reset when there is a change to heating mode or stopped by Remote Control Switch.

Automatic Fan Speed Mode

When Automatic Fan Speed is selected at Remote Control during cooling operation.

- Fan speed rotates in the range of Hi to Me.
- Deodorizing Control.

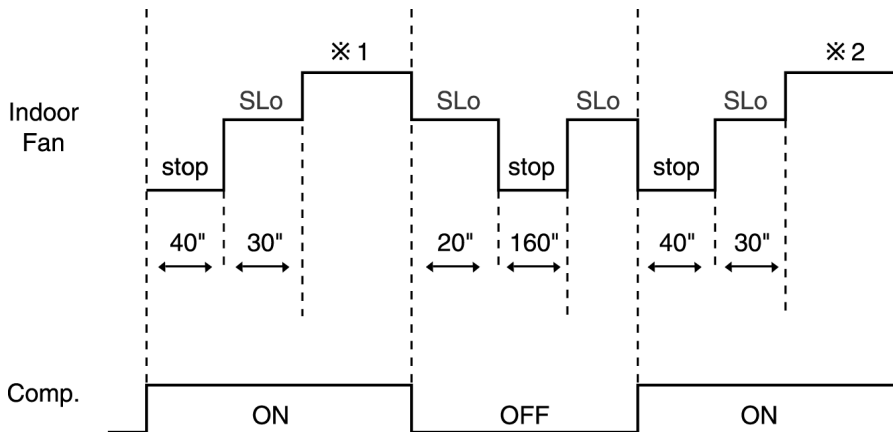

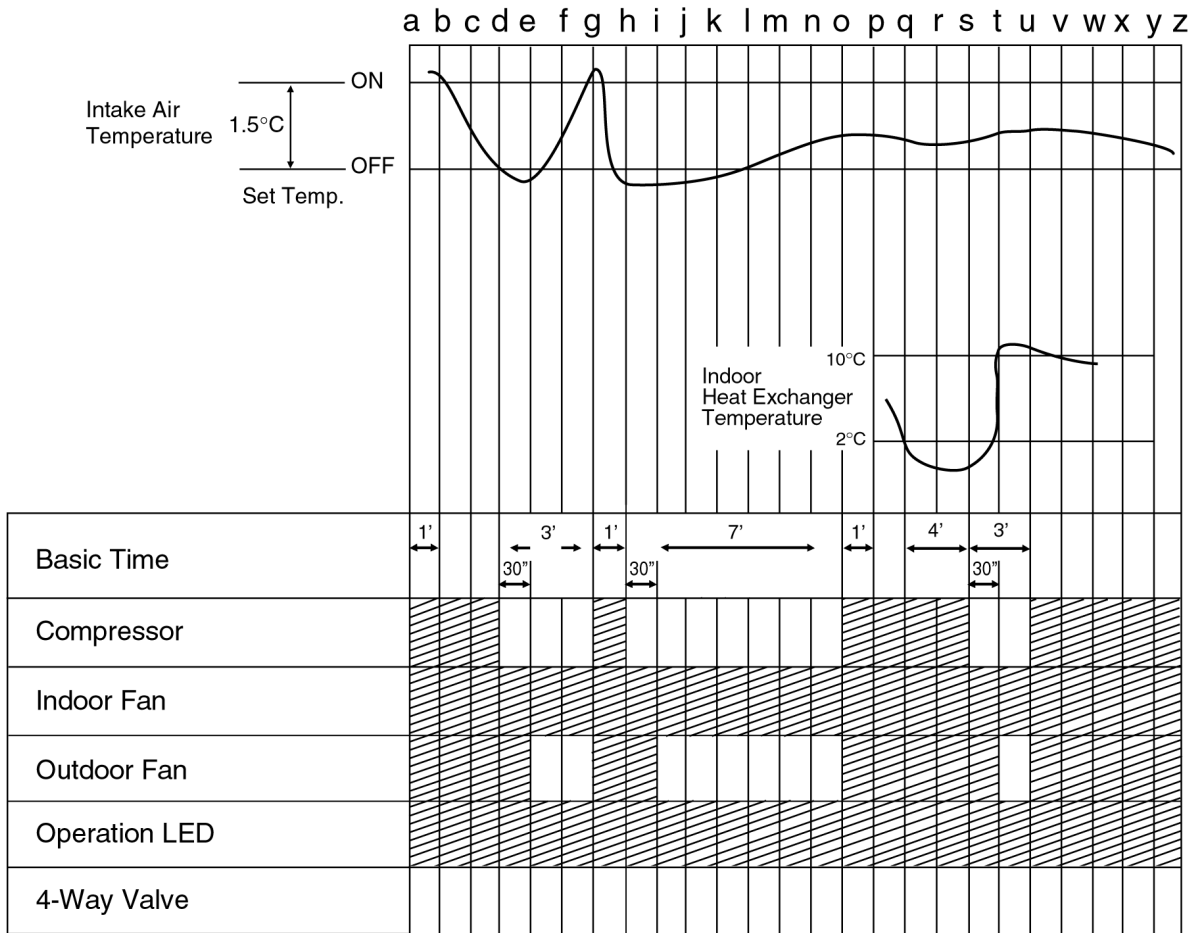

- ※ 1 Fan Speed is Hi until the compressor stops (when the room temperature reaches setting temperature).
- ※ 2 Fan Speed is Me after the compressor restarts.

Cooling Operation Time Diagram



<Description of operation>

- d – g : Time Delay Safety Control (waiting for 3 minutes)
- g – h : 60 sec. Forced Operation
- h – o : 7 min. Time Save Control
- q – u : Anti Freezing Control

 Operation
 Stop

Quiet Operation Control

(For Cooling Mode or cooling region of Soft Dry Mode)

- Purpose of this operation is to provide quite cooling operation compare to normal operation.
- When the Quiet Mode is set at the remote control, Quiet Mode LED illuminates, the sound level will be automatically decreased 2 dB (Lo), decreased 3 dB (Hi, Me), against the present sound level operation.
- Quiet setting of fan speed rpm refer to Indoor Fan Speed Control.
- Dew formation become severe at Quiet Lo cool, therefore Quiet Lo cool is operated only 1h 30 min (1h QLo, 30 min QLo + 50). After that, it goes back to Lo cool (However Quiet LED remains on).
- Manual Airflow Direction:-
 - RPM control during Lo cool

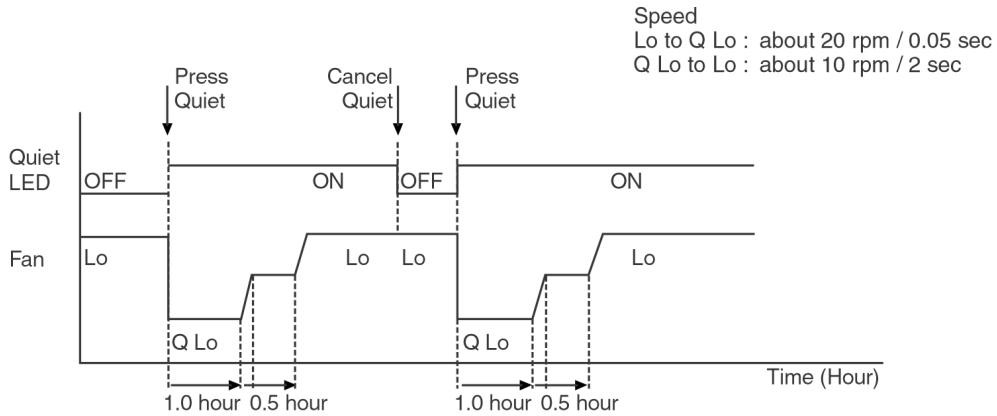

- RPM control during Hi & Me cool

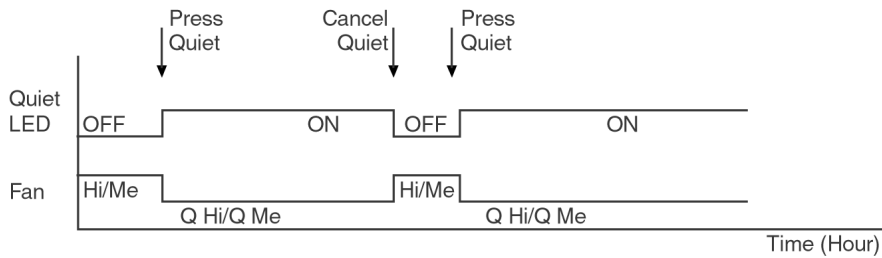

• Auto Airflow Direction:-

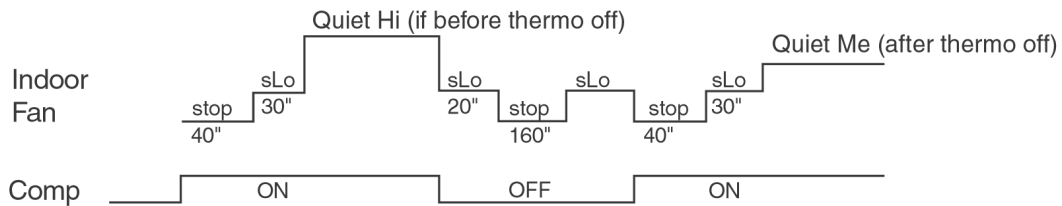

• Quiet Mode Operation will stop if:-

- Quiet mode button is pressed again.
- Stopped by ON/OFF switch.
- Timer OFF activates.
- Powerful mode button is pressed.
- When change mode to Air Circulation mode.

8.2. Soft Dry Mode Operation

- The unit starts cooling operation until the room temperature reaches the setting temperature set on the Remote Control, and then Soft Dry operation will start.
- During Soft Dry operation, the Indoor Fan will operate at Lo- speed.
- The operation will be switched on and off for up to 10 minutes “ON” and 6 minutes “OFF”. Once Soft Dry operation is turned off, it stops for 6 minutes.

Time Delay Safety Control

- Once the compressor stops, it will not start for 3 minutes during Cooling operation.

Starting Current Control

- Same as Starting Current Control for Cooling Mode operation.

Anti-Freezing Control

- Same as Anti-Freezing Control for Cooling Mode operation. (For Soft Dry region, 6 minutes waiting is valid during compressor stops.)

Compressor Reverse Rotation Protection Control

- Same as Compressor Reverse Rotation Protection Control for Cooling Mode Operation. (For Soft Dry region, 6 minutes waiting is valid during compressor stops.)

Compressor Protection Control

- Same as Compressor Protection Control for Cooling Mode Operation.

Automatic Fan Speed Mode

When Automatic Fan Speed is selected at Remote Control during Soft Dry operation.

- Fan speed rotates at Lo- speed.
- Deodorizing Control.

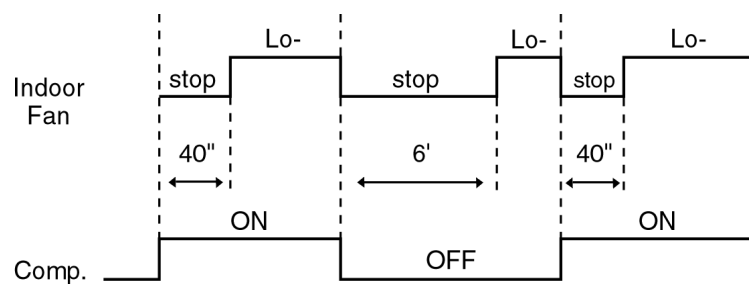

Soft Dry Operation Time Diagram

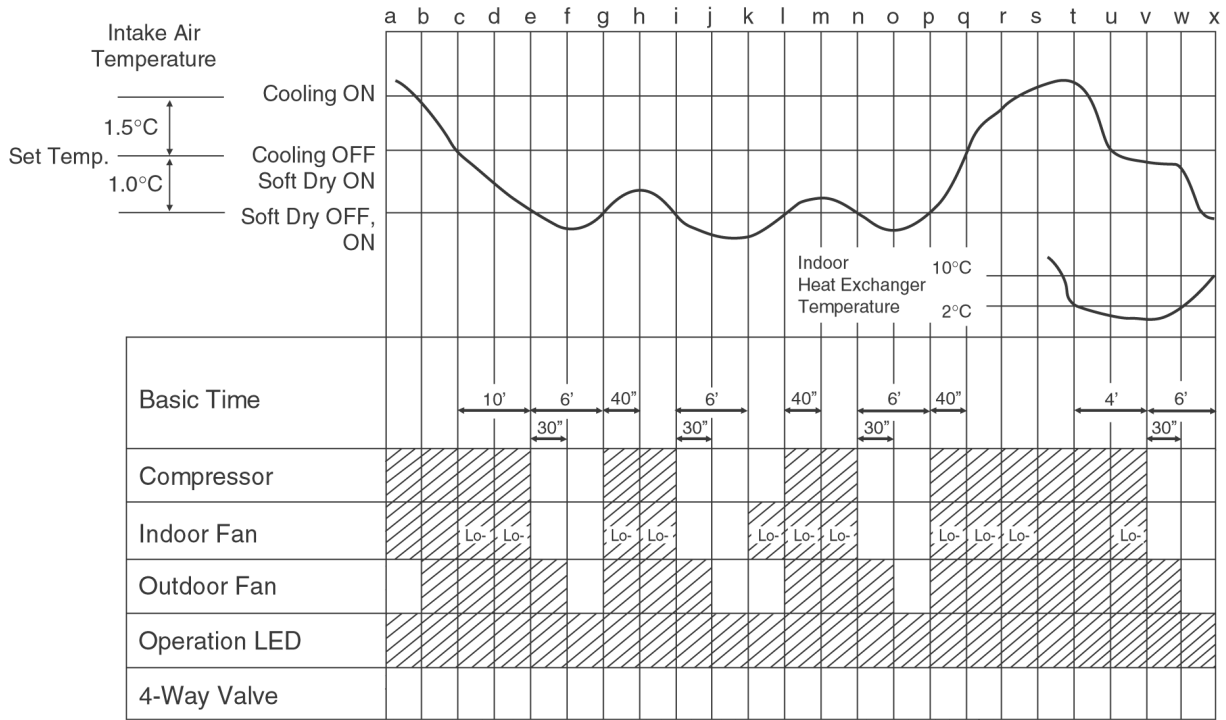

<Description of operation>

- a – c : Cooling Operation
- c – s : Soft Dry Operation
- e – g : Soft Dry OFF
- l – m : 60 sec. Forced Operation
- t – x : Anti Freezing Control



Quiet Operation Control

(For Dry region at Soft Dry Mode)

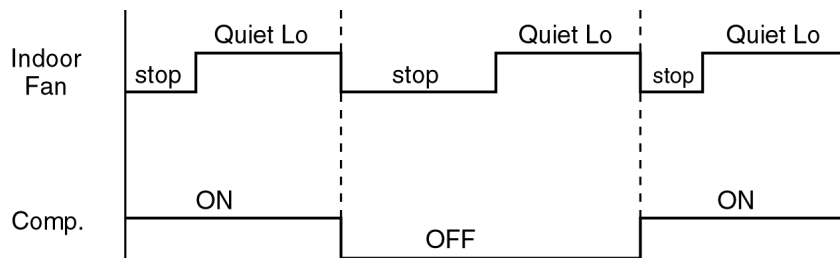

Note: Quiet Lo of Fan speed rpm refer to Indoor Fan Speed Control.

8.3. Heating Mode Operation

Heating in operation according to Remote Control setting.

Time Delay Safety Control

- When the compressor is stopped by Remote Control, it restarts after 3 minutes when the Remote Control is turned ON.
- When the setting temperature is reached during heating operation, the compressor stops and it will not start for 4 minutes.

30 minutes Time Save Control

- The compressor will start automatically if it has stopped for 30 minutes even if the room temperature is between the compressor ON temperature and OFF temperature.

Overload Protection Control

(a) Outdoor Fan Control

- If the temperature of the indoor heat exchanger rises to 51°C, Outdoor Fan stops.
The Outdoor Fan restarts when the indoor heat exchanger temperature falls to 49°C.

(b) Compressor high pressure protection

- If the indoor heat exchanger becomes 65°C or more, the compressor will stop and restart automatically.
(Time Delay Safety Control - 4 minutes waiting).



Compressor Reverse Rotation Protection Control

- If the compressor is operating continuously for 5 minutes or longer and temperature difference between intake air and indoor heat exchanger is 5°C or less for 2 minutes, compressor will stop and restart automatically.

(Time Delay Safety Control is valid).

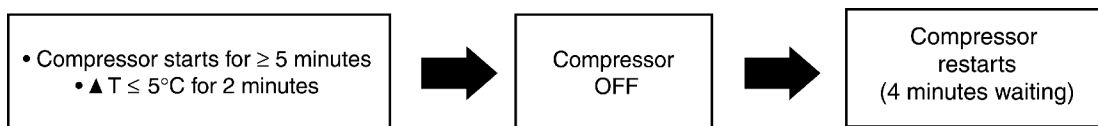

▲ T = Indoor heat exchanger temperature - intake air temperature.

This is to protect reverse rotation of the compressor when there is a instantaneous power failure.

4-way Valve Control

- 4-way valve always ON during Heating operation. (Except Deicing operation)
- When the unit is switched to "OFF" during Heating operation, 4-way valve stay at Heating position for 5 minutes.

Outdoor Fan Motor Control

- When compressor stops (reaches room temperature), outdoor fan will operate for 30 seconds.
(30 seconds Forced Operation).

Indoor Fan Motor Control

- When compressor stops (reaches room temperature), indoor fan will stop for 1 minutes, operate for 3 minutes, if still not yet reaches the room temperature, indoor fan Lo- for 40 sec. after that operate at SLo speed.

Hot Start Control

When Heating operation starts, Indoor Fan will not start until the indoor heat exchanger reaches 30°C as diagram shown.

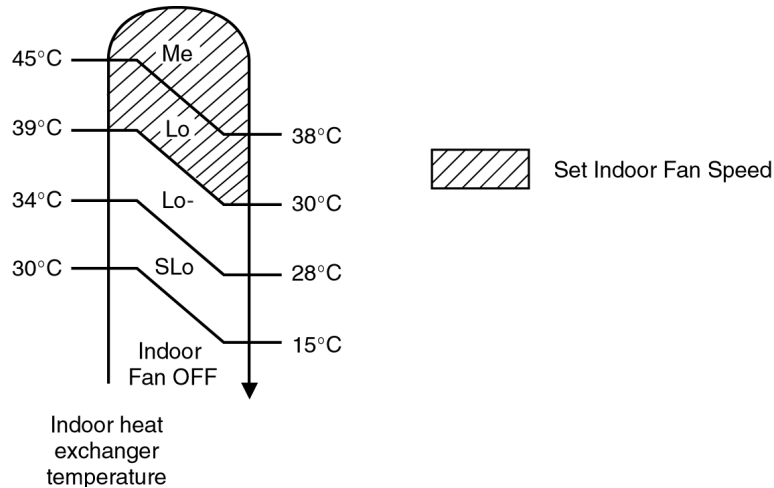

Hot Start is completed when indoor heat exchanger rises to 39°C or over 4 minutes.

Anti Cold Draft Control

- This operation is to prevent the Cold Draft during Heating mode operation.
- The operation will start when compressor OFF (Thermo OFF) during Heating operation.
- For the first 30 sec. from compressor OFF (Thermo OFF), Indoor fan speed will operate accordingly to the Indoor heat exchanger temperature as shown below:

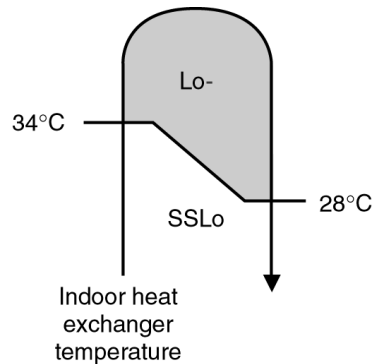

- After 30 sec. from compressor OFF (thermo OFF), Indoor fan will run at SSLo speed only.
- Anti Cold Draft Control will stop when:
 - Intake temperature < set temperature. (Time Delay Safety Control 4 minutes waiting is valid)
 - After 30 minutes time saved control. (refer to next page).

Automatic Fan Speed Mode

When Automatic Fan Speed is selected at Remote Control during heating operation.

- Fan speed rotates in the range of Me → SLo according to the heat exchanger temperature.

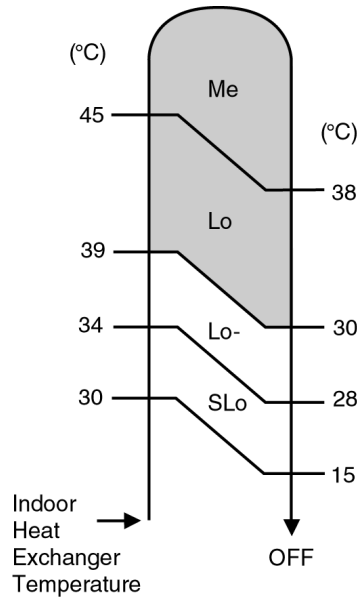

- If use Manual Fan Speed, at above diagram will operate with setting Fan Speed.

Heating Operating Time Diagram

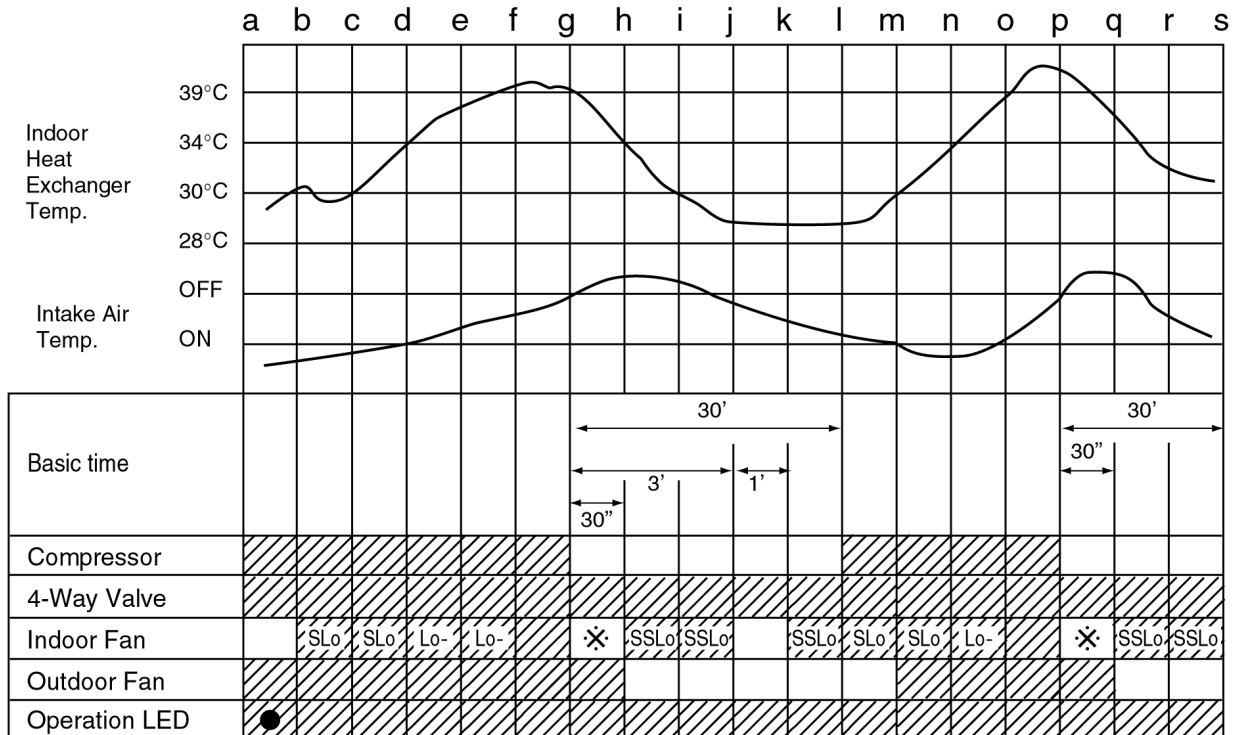

<Description of operation>

- a – b : Hot start (Indoor fan = OFF)
- b – d : Hot start (Indoor fan = SLo)
- g – m : Indoor fan control (anti cold draft control during thermostat OFF)
- g – h : Outdoor fan control (30 sec. Forced Operation) after compressor stops.

- : Blinking
- ✳ : Fan Speed will follow Indoor heat exchanger temperature.
- ▨ : Operation
- : Stop

Deicing Control

Deice starts to prevent frosting at outdoor heat exchanger.

- Normal Deicing

Deice operations detection commences after 30 minutes of Heating operation starts or 60 minutes after previous deice operation. If the TRS (Thermal Reed Switch) senses the outdoor piping temperature drops to -3°C (TRS CLOSE) or less for 50 sec. continuously during compressor is in operation, deice will start.

(There is no detection during Outdoor Fan stops.)

- Overload Deicing

During heating operation, if the outdoor Fan OFF duration (due to overload control) is accumulated up to 60 minutes and after compressor starts for 1 minutes, deicing starts.

- Deicing ends when

1. 12 minutes after deicing operation starts;
2. TRS senses the outdoor piping temperature rises to 4°C (TRS OPEN).
3. Deicing will not end immediately as time delay (T_d) is valid as shown below.

Time taken from deicing starts to TRS OPEN (T)	Deice recovery time	T_d (seconds)
$T \leq 1$ minutes	1 min. wait (Min.)	0
1 minutes $< T < 3$ minutes	T	0
3 minutes $< T < 8$ minutes	T + 60 sec.	60
8 minutes $< T < 11$ minutes	T + 120 sec.	120
$T > 11$ minutes	12 min wait (Max.)	—

- Once deicing operation starts, it will not end for 60 seconds.

- After deicing operation, compressor stops for 30 seconds and 4-way valve stays at cooling position for 10 seconds.

Normal Deicing Time Diagram

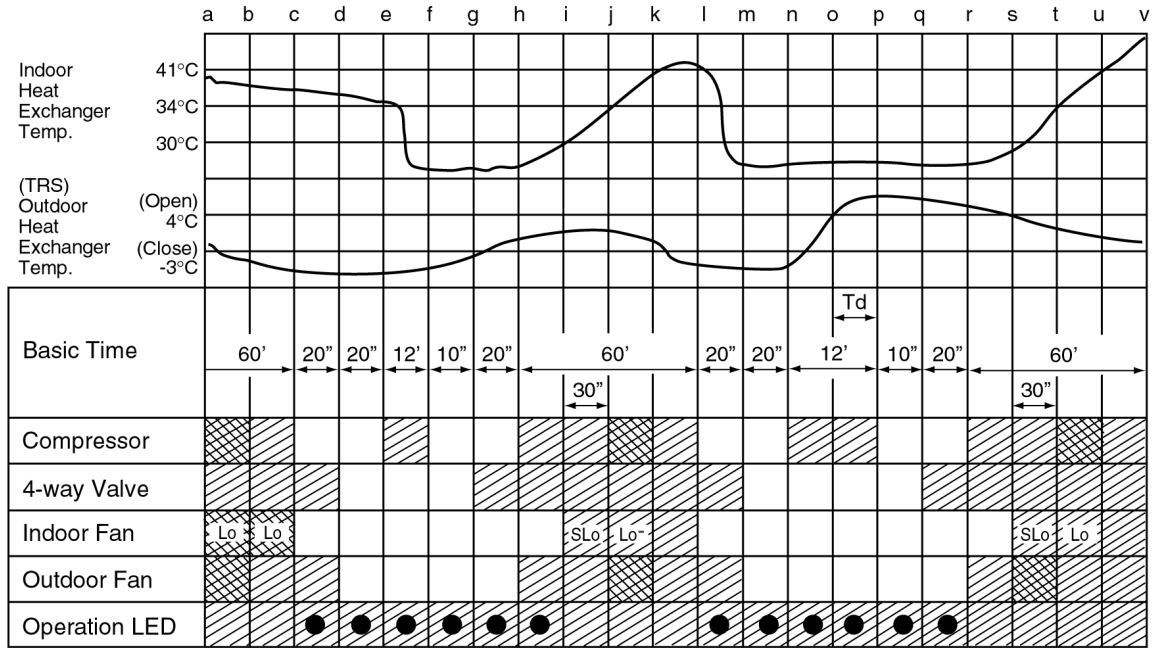

<Description of operation>

- a – c : Deicing operation judging condition established
- c – e, l – n : Deicing operation (timer detected)
- e – h : Deice operation (timer detected)
- h – i, r – s : Hot start (no thermo OFF)
- i – j, s – t : No thermo OFF (after finished hot start)
- n – r : Deicing operation (TRS detected)

- : Blinking
- ▨ : Operation
- : Stop
- ▩ : Operation or Stop

Overload Deicing Time Diagram

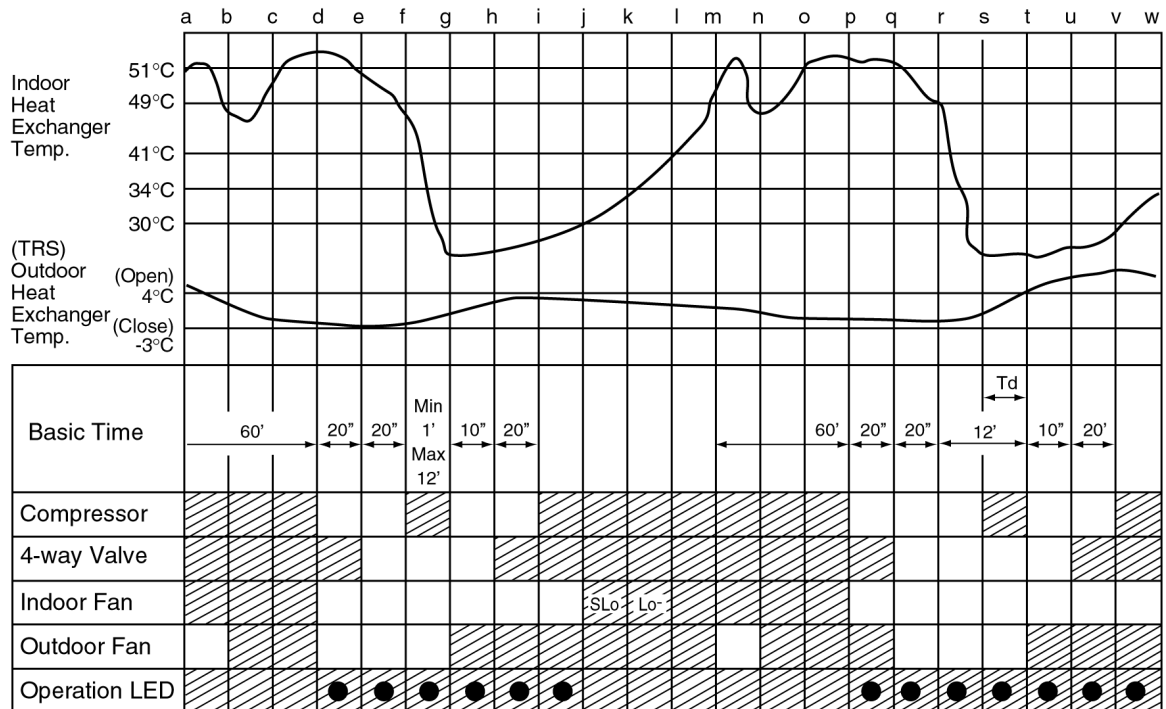

<Description of operation>

- a – d, m – p : Overload control. (intergrate)
- d – f, p – r : Preparation time for Deicing
- f – i : Overload deicing (timer detected)
- i – j : Hot start (indoor fan OFF)
- j – k : Hot start (indoor fan SLo)
- r – t : Overload control (TRS detected)

- : Blinking
- ▨ : Operation
- : Stop

Quiet Operation Control

(For Heating Mode)

- Purpose of this operation is to provide quite heating operation compare to normal operation.
- When the Quiet Mode is set at the remote control, Quiet Mode LED illuminates, the sound level will be automatically decreased 2 dB (Lo), decreased 3 dB (Hi, Me), against the present sound level operation.
- Quiet setting of fan speed rpm refer to Indoor Fan Speed Control.
- Manual Airflow Direction:-
 - Rpm control during Lo, Me & Hi Cool

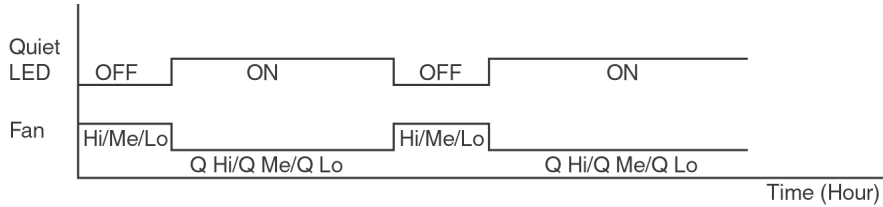

- Auto Airflow Direction:-
 - Rpm control depends on the piping air temperature sensor of Indoor heat exchanger

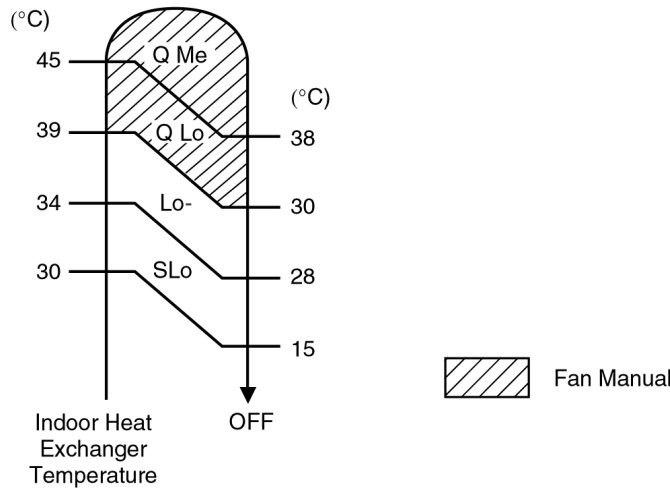

- Quiet Mode Operation will stop if:-
 - Quiet mode button is pressed again.
 - Stopped by ON/OFF switch.
 - Timer OFF activates.
 - Powerful mode button is pressed.

8.4. Automatic Mode Operation

1. When the Automatic Mode Operation is selected, the indoor fan operates at SLo fan speed for 25 seconds to sense intake air temperature and determine the 1st operation mode.

Standard for Determining Operation Mode 1st Judgement

↑ Intake Air Temperature	23°C	Cooling Mode
	20°C	Soft Dry Mode
		Heating Mode

Operation Mode	Setting Temperature (Standard)
Cooling	25°C
Soft Dry	22°C
Heating	21°C

2. Operation mode will be determine again after 1 hour of operation, if the room temperature reaches to set temperature and compressor off time is over 7 minutes 30 seconds continuously.

- ✗ The present operation mode will be continued, if the room temperature does not reach to set temperature (Compressor keeps running) eventhough after 1 hour from automatic operation mode started.

Standard for Determining Operation Mode 2nd Judgement onwards

Present Mode	Judgement	Next Mode		
		Cooling	Soft Dry	Heating
Cooling	23°C Cooling Heating	○ (Judgement: 23°C & Above)	Not Applicable	○ (Judgement: Below 23°C)
Soft Dry	20°C Soft Dry Heating	Not Applicable	○ (Judgement: 20°C & Above)	○ (Judgement: Below 20°C)
Heating	25°C Cooling Heating	○ (Judgement: Above 25°C)	Not Applicable	○ (Judgement: 25°C & below)

- ✗ Automatic Set Temperature
Refer 3. as below.

3. Automatic Set Temperature

For each operation, set temperature will automatically set as shown below.

However it can be selected 2°C higher or 2°C lower from standard set temperature by pressing the “Room Temperature Setting button”.

Operation	Hi	(Standard)	Lo
	(+2°C)	(±0°C)	(-2°C)
Cooling	27°C	25°C	23°C
Soft Dry	24°C	22°C	20°C
Heating	23°C	21°C	19°C

- The mode judging temperature and standard setting temperature can be increased by 2°C, by open the circuit of JX1 at indoor electronic controller.

↑ Intake Air Temperature	25°C	Cooling Mode
	22°C	Soft Dry Mode
		Heating Mode

Operation Mode	Setting Temperature (Standard)
Cooling	27°C
Soft Dry	24°C
Heating	23°C

8.5. Random Auto Restart Control

- If there is a power failure during air conditioner operation, operation will be automatically restarted after 3 to 4 minutes when the power is resumed. It will start with previous operation mode and airflow direction.
- Restart time is decided randomly using 4 parameter:
Intake air temperature, setting temperature, fan speed and Air Swing Blade position.
- Random Auto Restart Control is not available when Timer is set.
- This control can be omitted by open the circuit of JX2. (Refer Circuit Diagram)

8.6. Delay ON Timer Control

- When the Delayed ON Timer is set by using the remote control, the unit will start operate slightly before the set time, so that the room will reach nearly to the set temperature by the desired time.
- For Cooling and Soft Dry mode, the operation will start 15 minutes before the set time.
- For Heating mode, the operation will start 30 minutes before the set time.
- For Automatic mode, the indoor fan will operate at SLo speed for 25 seconds, 30 minutes before the set time to detect the intake air temperature to determine the operation mode. The operation indication lamp will blink at this time.

8.7. Remote Control Signal Receiving Sound

- Long beep sound will be heard when:-
 - Stopping the Air Conditioner using ON/OFF switch.
 - Stopping the Quiet Mode.
 - Stopping the Powerful Mode.
 - Stopping the Ion Mode.
- Short beep sound will be heard for others.
- To switch off the beep sound:-
Press the "Automatic Operation Button" continuously for 10 seconds or more ("beep" "beep" will be heard at the 10th second).
Repeat the above if you want to switch ON the beep sound.

⊗ However, if the "Automatic Operation Button" has been pressed the Automatic operation will be activated.
If you do not require this operation, you may change it by using the remote control.

8.8. Indoor Fan Speed Control

Auto Fan Speed Control

When set to Auto Fan Speed, the fan speed is shifted automatically between Stop to SHi depend on each operation as shown below.

Manual Fan Speed Control

Basic fan speed adjustment (3 settings, from Lo to Hi) can be carried out by using the Fan Speed selection button at the remote control.

Tap			S Hi	Hi	Me	H Lo	C Lo	Lo-	S Lo	SSLo	Stop	
Cooling	Normal	Manual	Hi	○								
			Me		○							
			Lo				○					
	Air Volume Auto			○	○				○		○	
	Powerful	Manual		○								
		Air Volume Auto		○								
Economy	Manual							○				
	Air Volume Auto							○				
Dry	Manual							○			○	
	Air Volume Auto							○			○	
Heating	Normal	Manual	Hi	○					○	○	○	○
			Me			○			○	○	○	○
			Lo				○		○	○	○	○
		Air Volume Auto				○	○		○	○	○	○
	Powerful	Manual		○		○	○		○	○	○	○
		Air Volume Auto				○	○		○	○	○	○
	Economy	Manual		○		○	○		○	○	○	○
		Air Volume Auto				○	○		○	○	○	○
Mode judgement									○			
Cooling	Quiet	Manual	Q Hi		Hi-100							
			Q Me			Me-100						
			Q Lo					CLo-100				
		Air Volume Auto				Hi-100	Me-100				○	○
Dry	Quiet	Manual						CLo-100			○	
		Air Volume Auto						CLo-100			○	
Heating	Quiet	Manual	Q Hi	SHi-100					○	○	○	○
			Q Me			Me-100			○	○	○	○
			Q Lo				HLo-70		○	○	○	○
		Air Volume Auto					Me-100	HLo-70		○	○	○
Ion	Manual			○	○		○					
	Air Volume Auto					○	○					

Fan Speed (Rpm)	CS-W12CKP	CS-W9CKP	CS-W7CKP
S Hi	1300	1280	1190
Hi	1260	1160	1050
Me	1120	980	940
H Lo	960	840	840
C Lo	900	800	800
Lo-	870	770	770
S Lo	750	700	700
SS Lo	300	300	300
Q S Hi	1200	1180	1090
Q Hi	1160	1060	950
Q Me	1020	880	840
Q H Lo	890	770	770
Q Lo	800	700	700

8.9. Airflow Direction Control

1. Vertical Airflow Direction

Cooling, Ion and Soft Dry Mode

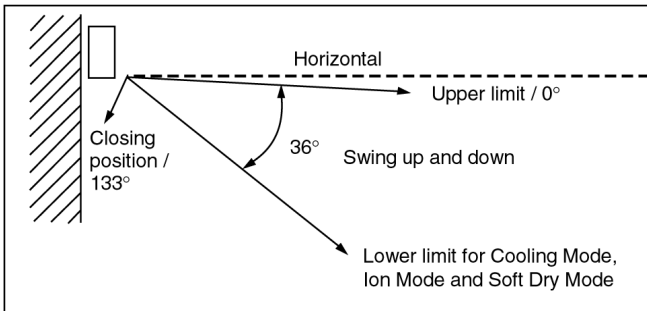

- The louver swings up and down as shown above.
- The louver does not swing when the Indoor Fan stops during operation at the upper limit.

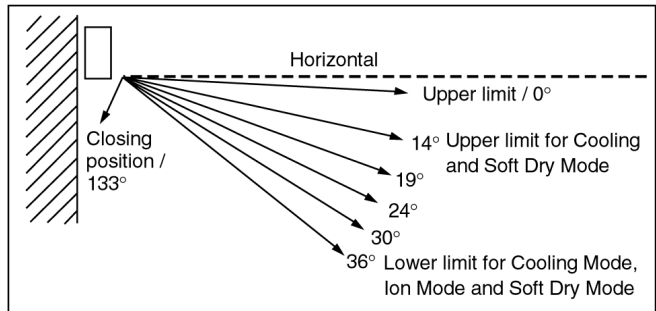

- The louver can be selected between 14° - 36° (as shown above) when pressing Manual Airflow Direction Selection Button.

Heating Mode

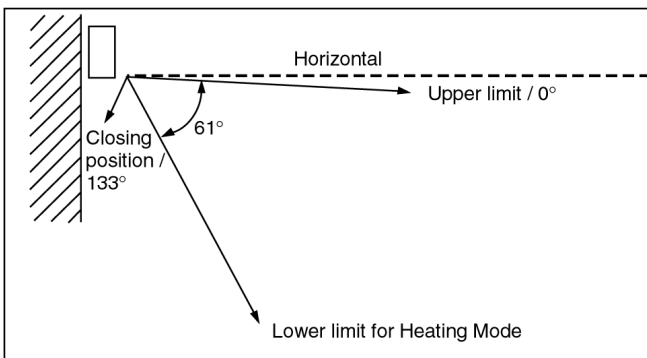

- When the intake air temp. reaches 38°C, the louver is changed from upper to lower limit. When the intake air temp falls to 35°C, the louver is changed from lower to upper limit.

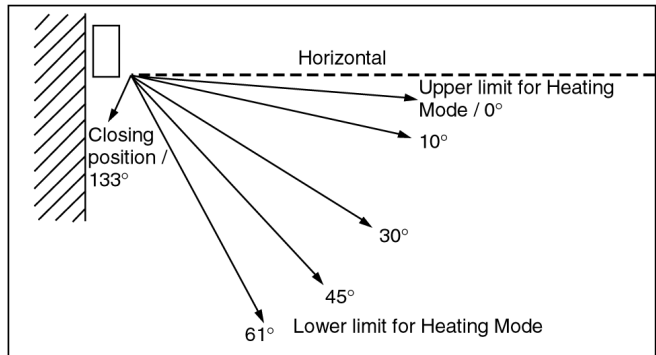

- The louver can be selected between 0° - 61° (as shown above) when pressing Manual Airflow Direction Selection Button.

2. Horizontal Airflow Direction

- The left and right airflow direction louvers can be adjusted manually.

8.10. Powerful Mode Operation

Purpose of this operation is to be obtain the setting temperature quickly.

1. Cooling and Soft Dry Mode

- When the Powerful Mode is set, the set temperature will be automatically decreased 3°C against the present setting temperature (Lower temperature: 16°C). This operation automatically will be running under SHi Fan speed (cooling), Lo-Fan Speed (Soft Dry).
- Vertical Airflow Direction:-
In "Manual" setting, the vane will automatically shift down 10° lower than previous setting.
In "Auto" setting, the vane will automatically swing up and down. However the upper and lower limit will be shifted 10° downward.

2. Heating Mode

- When the Powerful Mode is set, the set temperature will be automatically increased 3°C against the present setting temperature (Higher temperature: 30°C).
- The Fan Speed will shift as shown below:

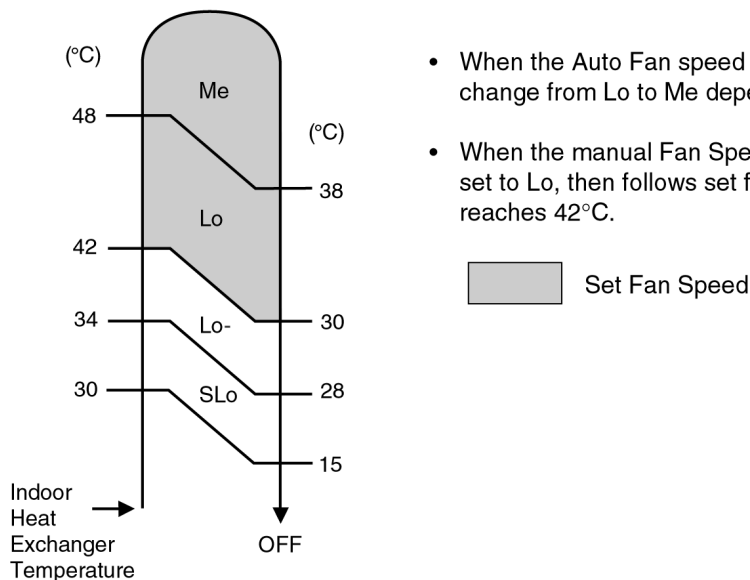

- When the Auto Fan speed is selected, the fan speed will automatically change from Lo to Me depending to the Indoor piping temperature.
- When the manual Fan Speed is selected, the fan speed will automatically set to Lo, then follows set fan speed when the Indoor piping temperature reaches 42°C.

- Vertical Airflow Direction:-

In "Manual" setting, the vane will automatically shift down 5° lower than previous setting.

In "Auto" setting, the vane will automatically shift between upper and lower limit depending on the intake air temperature as Heating Mode, Airflow Direction Auto-Control. However the upper and lower limit will be shifted 5° downward.

3. Powerful mode will operate for 15 minutes only.

4. Powerful Mode will stop if:

- Powerful mode button is pressed again.
- Stopped by ON / OFF switch.
- Timer-off activates.
- Quiet mode button is pressed.
- Operating mode is changed.

8.11. Ionizer Operation

Purpose

To provide fresh air effect to user by producing minus ion in discharge air.

Control Condition

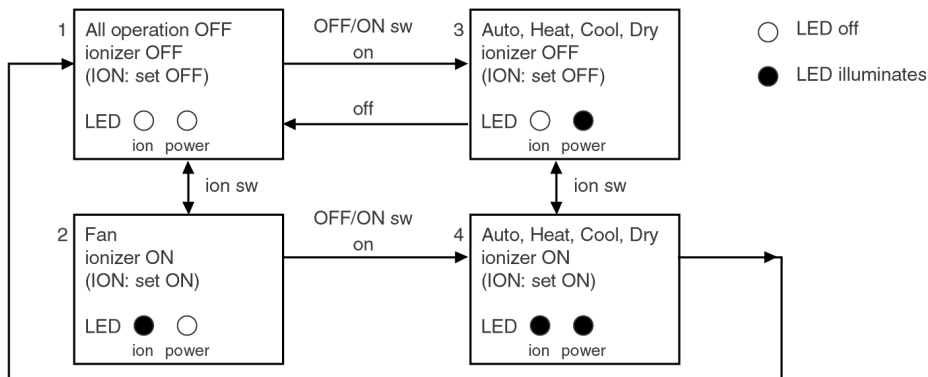

a. Ionizer Only Operation.

1. When air-conditioner unit is at “OFF” condition (standby) and ION operation button at remote controller is pressed.

Fan & ionizer on, ION LED illuminates, but power LED maintain off. (1 → 2)

However, fan speed can be adjusted later by customer during this operation.

Fan speed	
manual	Remote set fan tap
Auto	between H Lo & C Lo at the pattern shown below

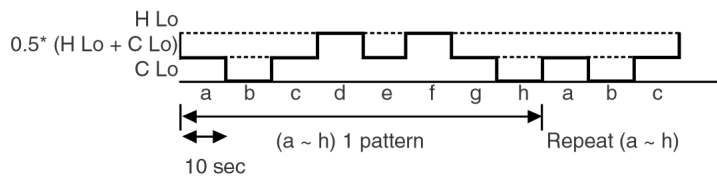

Air flow direction (Horizontal Vane) control:

Follow vane direction control at cooling mode.

Horizontal vane can be changed by customer during ion only operation.

2. Ion only operation can be off by pressed ION button again. (2 → 1)

3. It can be changed to previous operated mode (Auto, Heat, Cool, Dry) + ion operation by OFF/ON switch. (2 → 4)

4. During ion only operation, if power failure occur, after power resume, ionizer & air-conditioner resumes immediately.

5. After error = 24 times, (about 11h 30 min.), ion & fan off with Ion LED blinks continuously.

(Detail refer to Ionizer Error detection control.)

b. Operation Mode + Ionizer Operation.

1. Ionising Operation Start Condition

When air-conditioner unit is in “ON” condition (Heat, Cool, Dry, Auto mode) and ION operation button at remote controller is pressed. Ionizer on & ION LED illuminates. (3 → 4)

Power LED also illuminates.

2. Ionising Operation Stop Condition

When one of the following condition is satisfied, ION operation stops.

- a. Stopped by ON/OFF switch.
- b. Timer OFF activates.
- c. ION operation button is pressed again.
- d. ION feedback signal shows error.

3. Ionizer operation status is not memorised after off. After OFF, when operation is "ON" again, air-conditioner operates without ionizer operation.

However, during Cool mode etc. + ionizer operation, if there is a power failure & then power resume, A/con shall on at that mode + ionizer operation.

c. Timer during ionizer operation

Refer to case study in next page for detail.

8.11.1. Ionizer Error Detection Control

A. Purpose

To inform user that error occurs at ionizer system so that repairing job can be carried out.

B. Two type of error detection control:

(a) When Ionizer is ON (example case: Ionizer shorted, ionizer over current protection)

- During ionizer ON operation, when feed back voltage = Lo (micon input) is detected, Ion is OFF. If feedback = Lo for 11 hrs 30 min, ION LED blinks continuously.
- To cancel ion LED blinking, press ion button at remocon (or forcible operation sw at a/con unit). If ion button is pressed again, ion LED blinks again.
- The error can be reset by:
 - i) Operation ON/OFF button press to operation OFF.
 - ii) Forcible switch press to operation OFF.
 - iii) Operation OFF due to Timer OFF reach.
 - iv) Timer set ON & operation from ON to OFF (only applicable to 12 hrs timer models).

(b) When Ionizer is OFF (example case: ionizer connecting wire loose)

- During air conditioner is at standby or ON operation and ionizer at OFF condition, if ionizer feed back voltage = Hi (micon input) is detected, Ionizer breakdown detection control is activated and ion LED immediately blinks.
- To cancel Ion LED blinking, press ion button at remocon (or forcible operation sw at a/con unit). If ion button is pressed again, ion LED blinks again.
- During ionizer at breakdown condition, if ionizer feedback voltage = Lo (become OK), ion LED will stop blinking.

8.11.2. Ionizer Operation case study

Case 1a: Ionizer only operation (12h delay timer ON)

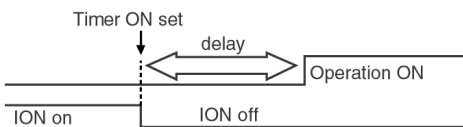

Case 1b: Ionizer only operation (12h delay timer OFF)

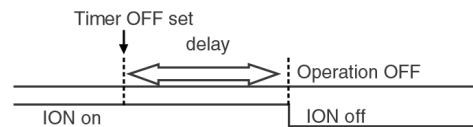

Case 2a: Ionizer only operation (24h real time timer ON)

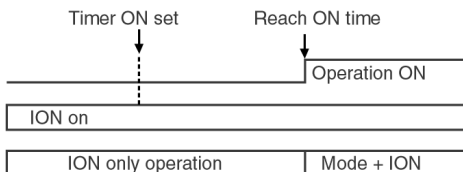

Case 2b: Ionizer only operation (24h real time timer OFF)

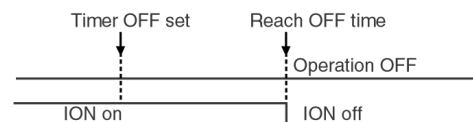

Case 3a: Operation Mode + Ionizer (12h delay timer ON)

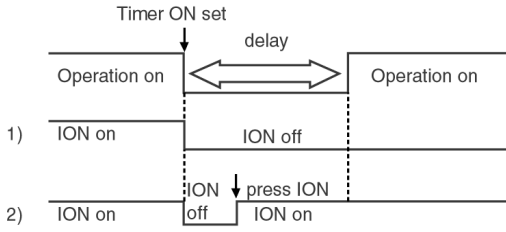

Case 3b: Operation Mode + Ionizer (12h delay timer OFF)

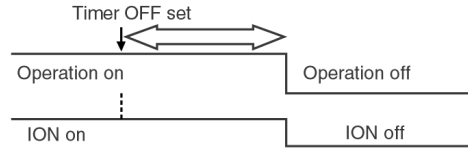

Case 4a: Operation Mode + Ionizer (24h real time timer ON)

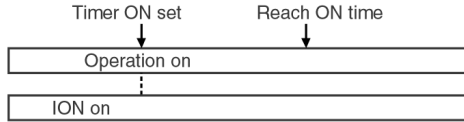

Case 4b: Operation Mode + Ionizer (24h real time timer OFF)

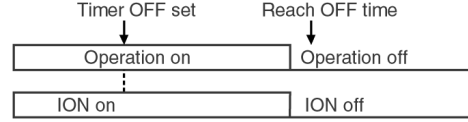

Case 5a: Ionizer only operation (24h real time timer ON)

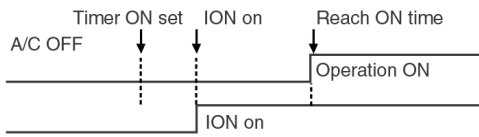

Case 5b: Ionizer only operation (24h real time timer OFF)

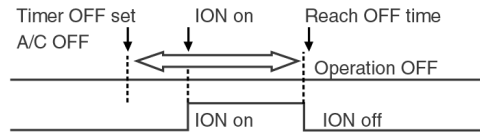

Case 6a: Ionizer only operation (12 delay timer ON)

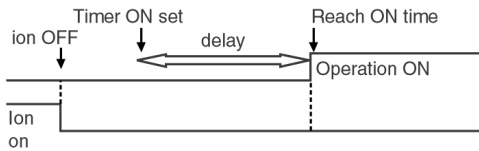

Case 6b: Ionizer only operation (24h real time timer ON)

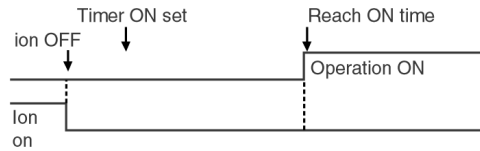

Case 7a: Operation Mode + Ionizer (12 delay timer ON)

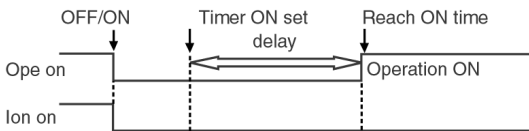

Case 7b: Operation Mode + Ionizer (24h real time timer ON)

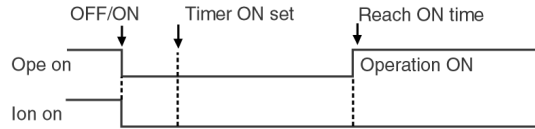

Case 8: Ionizer only operation (Auto Fan) & shift to Cool Mode

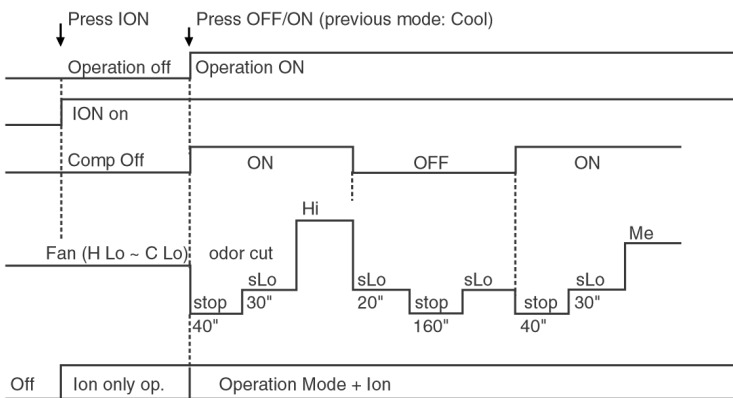

OUTPUT

lonizer stand alone ON/OFF & protection control

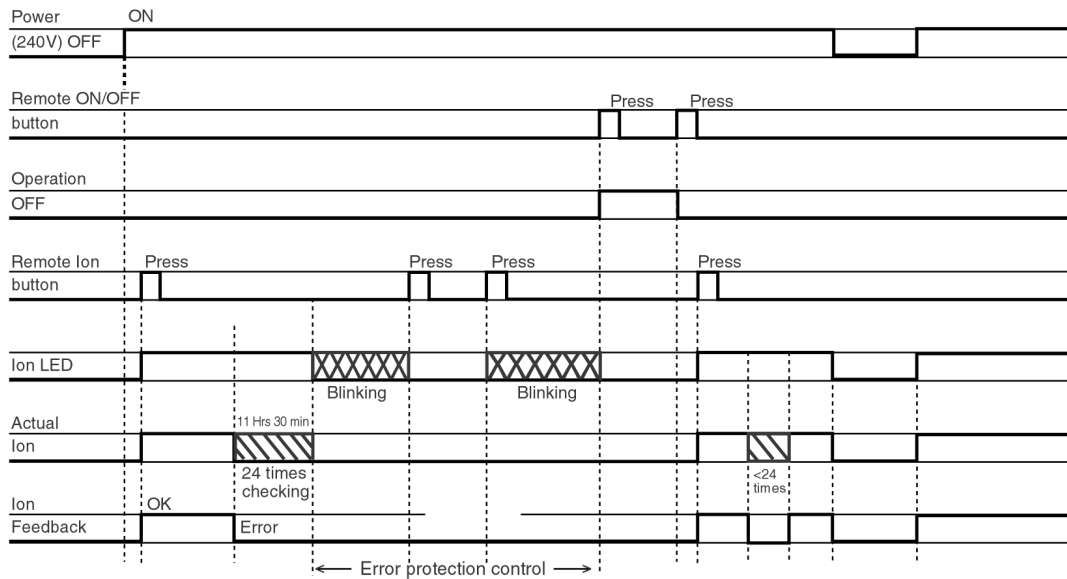

lonizer + mode ON/OFF & protection control:

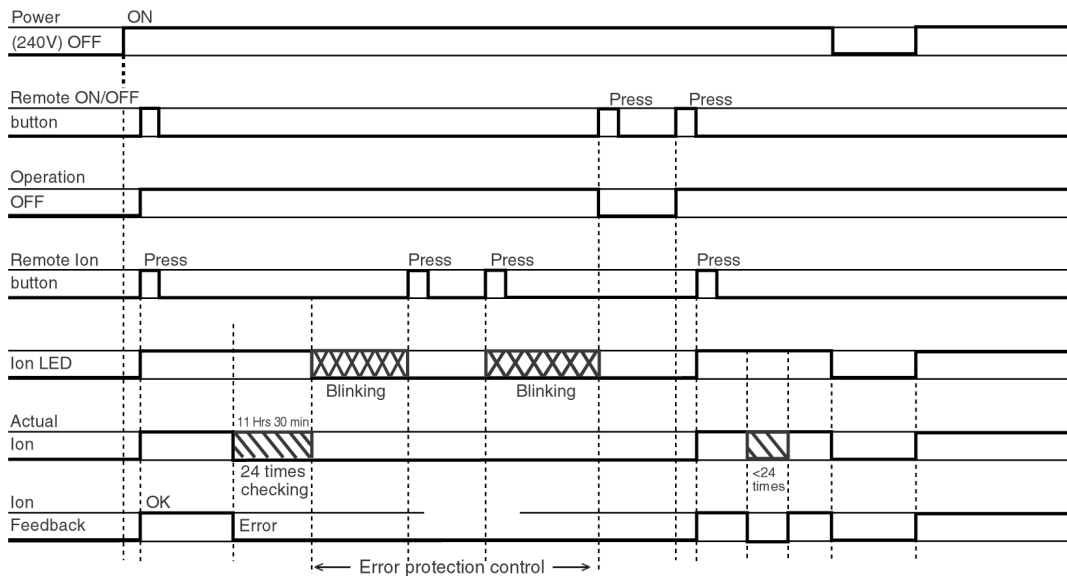

Note:

1. 24 times checking: Actual Ion ON for 10s & OFF for 1s 30 min continuously for 24 times.
2. 24 times count will be cleared when following conditions happen.
 - a) 24 times count over, b) lonizer cancel if press Ion button or power reset, c) Ion f/b sgnl OK.
3. Error protection will be cleared when following conditions happen.
 - a) Power reset, b) Remocon operation ON/OFF button press, c) Forcible operation press, d) Opt OFF due to Timer OFF
4. Ion auto restart: Ion will auto restart if Actual Ion was ON with no error protection control before power shutdown. Otherwise Ion will not auto restart.
5. Ion LED blinking can ON/OFF during error protection by following conditions:
 - a) Press remocon ion button
 - b) Press emergency opt SW to OFF blinking.

OUTPUT

Ion breakdown protection control: (Only during Actual Ion OFF)

Case 1: Operation OFF & Ionizer OFF

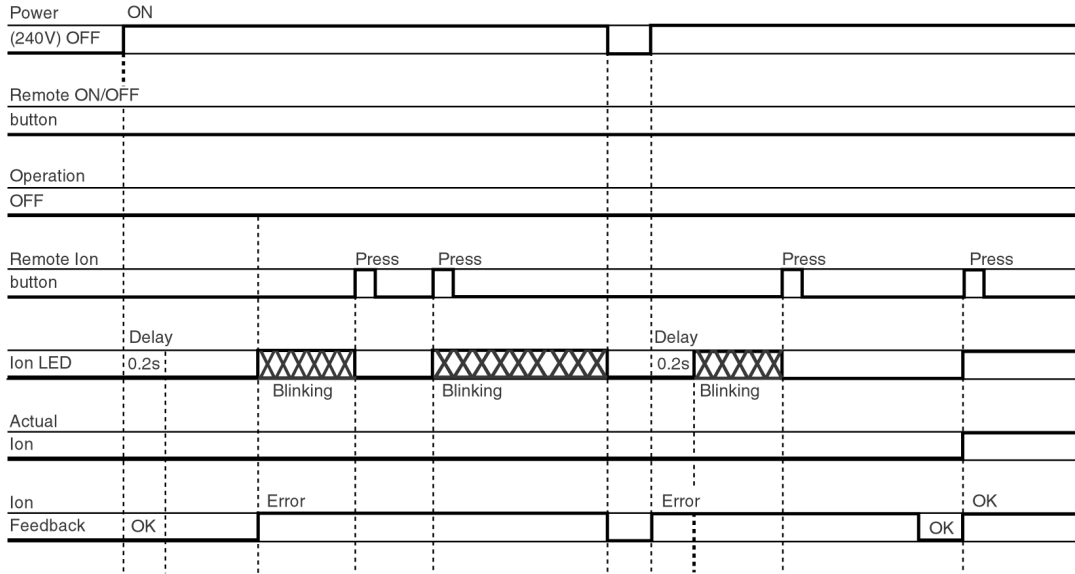

Case 2: Operation ON & Ionizer OFF

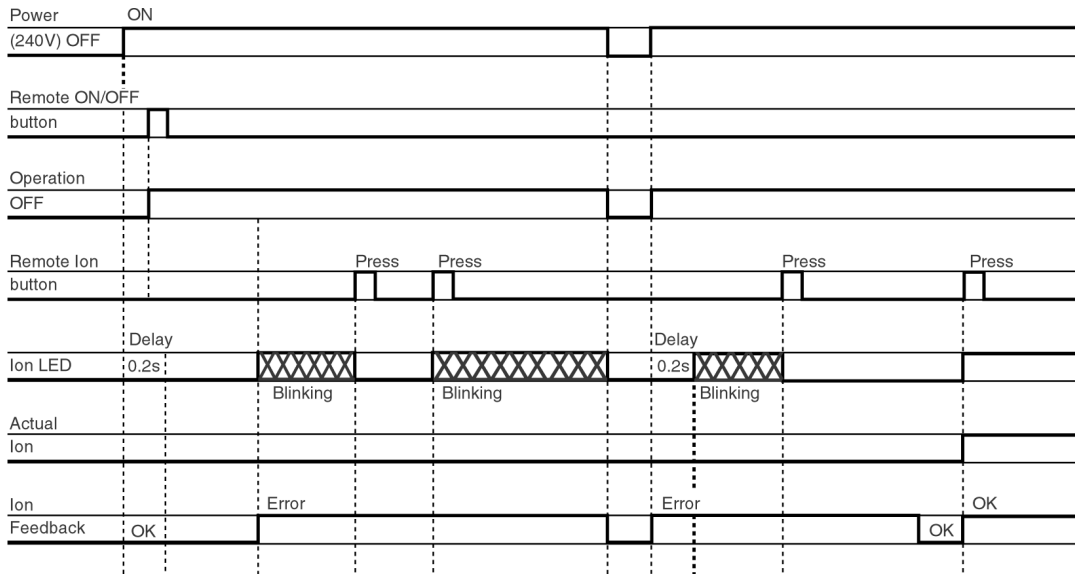

9 Operating Instructions

SAFETY PRECAUTIONS

Before operating, please read the following "Safety Precautions" carefully.

- To prevent personal injury, injury to others and property damage, the following instructions must be followed.
- Incorrect operation due to failure to follow instructions will cause harm or damage, the seriousness of which is classified as follow.

Warning
This sign warns of death or serious injury.

Caution
This sign warns of damage to property.

- The instructions to be followed are classified by the following symbols:

This symbol (with a white background) denotes an action that is PROHIBITED.

These symbols (with a black background) denote actions that are COMPULSORY.

Installation Precautions

Warning

- Do not install, remove and reinstall the unit by yourself.**
Improper installation will cause leakage, electric shock or fire. Please engage an authorized dealer or specialist for the installation work.

Caution

- This room air conditioner must be earthed.**
Improper grounding could cause electric shock.
- Ensure that the drainage piping is connected properly.**
Otherwise, water will leak out.
- Do not install the unit in a potentially explosive atmosphere.**
Gas leak near the unit could cause fire.

Operation Precautions

Warning
This sign warns of death or serious injury.

- Do not share outlet.
- Do not insert plug to operate the unit. Do not pull out plug to stop the unit.
- Do not operate with wet hands.
- Do not damage or modify the power cord.
- Do not insert finger or other objects into the indoor or outdoor units.
- Do not expose directly to cold air for a long period.

- Plug in properly.
- Use specified power cord.

- If abnormal condition (burnt smell, etc.) occurs, switch off and unplug the power supply.

Caution
This sign warns of injury.

- Do not pull the cord to disconnect the plug.
- Do not wash the unit with water.
- Do not use for other purposes such as preservation.
- Do not use any combustible equipment at airflow direction.
- Do not sit or place anything on the outdoor unit.

- Switch off the power supply before cleaning.
- Ventilate the room regularly.
- Pay attention as to whether the installation rack is damaged after long period of usage.

- Switch off the power supply if the unit is not used for a long period.

NAME OF EACH PART

Indoor Unit

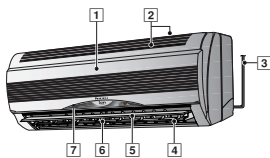

- 1 Front Panel
- 2 Air Intake Vent
- 3 Power Supply Cord
- 4 Air Outlet Vent
- 5 Vertical Airflow Direction Louver
- 6 Horizontal Airflow Direction Louver (manually adjusted)
- 7 Indicator Panel

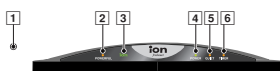

- 1 Auto Operation Button (when the front panel is opened)
- 2 Powerful Mode Indicator - ORANGE
- 3 Ionizer Mode Indicator - GREEN
- 4 Power Indicator - GREEN
- 5 Quiet Mode Indicator - ORANGE
- 6 Timer Mode Indicator - ORANGE

Indoor Unit (when the front panel is opened)

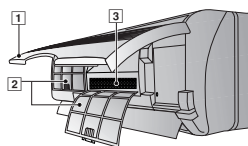

- 1 Front Panel
- 2 Air Filters
- 3 Air Purifying Filter

Outdoor Unit

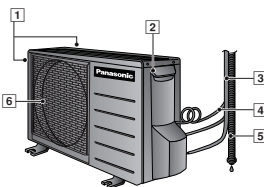

- 1 Air Intake Vents
- 2 Ground Terminal (inside cover)
- 3 Piping
- 4 Connecting Cable
- 5 Drain Hose
- 6 Air Outlet Vents

Accessories

Remote Control



Remote Control Indication Sticker

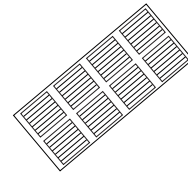

Remote Control Holder



Two RO3 (AAA) dry-cell batteries or equivalent



Air Purifying Filter

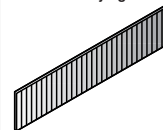

(Catechin Air Purifying Filter)

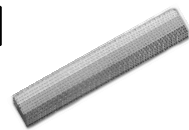

(Triple Deodorizing Filter)

NAME OF EACH PART

■ Remote Control

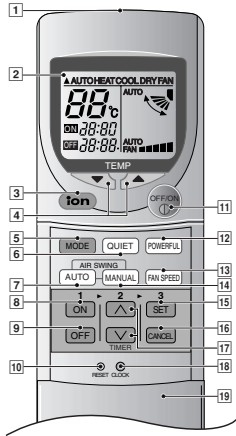

- 1 Signal Transmitter
- 2 Operation Display
- 3 Ionizer Mode Operation Button
- 4 Room Temperature Setting Button (illuminating button)
- 5 Operation Mode Selection Button
- 6 Quiet Mode Operation Button
- 7 Auto Airflow Direction Button
- 8 ON-Timer Button
- 9 OFF-Timer Button
- 10 Reset Point (Press with fine-tipped object to clear the memory)
- 11 OFF/ON Button (illuminating button)
- 12 Powerful Mode Operation Button
- 13 Fan Speed Selection Button
- 14 Manual Airflow Direction Selection Button
- 15 Timer Set Button
- 16 Timer Cancellation Button
- 17 Time-Setting Button
- 18 Clock Button
- 19 Remote Control Cover

- **Remote Control Signal.**
 - Make sure it is not obstructed.
 - Maximum distance : 10 m.
 - Signal received sound.
 - One short beep or one long beep.
- **Notes for Remote Control.**
 - Do not throw or drop.
 - Do not get it wet.
 - Certain type of fluorescent lamps may affect signal reception. Consult your dealer.

● How to Insert the Batteries

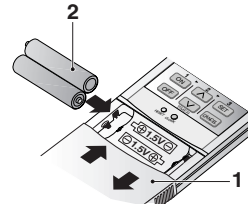

1 Slide down the remote control cover completely

2 Insert the batteries
 – Be sure the direction is correct
 – 12.00 at display - flashing
 • Set the current time (CLOCK) immediately to prevent battery exhaustion.

- **About the batteries**
 - Can be used for approximately one year.
- **Observe the following when replacing the batteries**
 - Replace with new batteries of the same type.
 - Do not use rechargeable batteries (Ni-Cd).
 - Remove the batteries if the unit is not going to be used for a long period.

PREPARATION BEFORE OPERATION

■ Indoor Unit

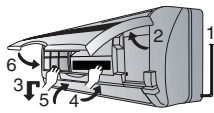

- 1 Connect the power supply cord to an independent power supply
- 2 Open the front panel
- 3 Remove the air filters
- 4 Fit the air purifying filters in place
- 5 Insert the air filters
- 6 Close the front panel

■ Remote Control

– To set the current time

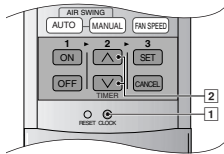

- 1 Press [1].
- 2 Then press [2] to increase or decrease the time.
- 3 Press [1] again.
Set time at display will light up.

HOW TO OPERATE

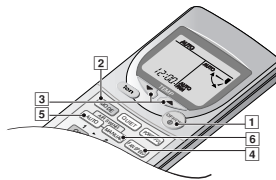

- **To start the operation**
 - Press [1].
 - POWER indicator (green) on the indoor unit will light up.
 - To stop, press once more.

- **Setting Mode**
 - Press [2] to select:-

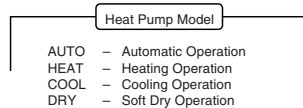
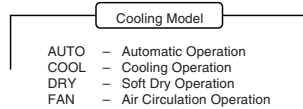

■ Setting Temperature

- Press [3] to increase or decrease the temperature.
- The temperature can be set between 16°C ~ 30°C.
- Recommended temperature:

Cooling Model		Heat Pump Model	
COOL	→ 26°C ~ 28°C	COOL	→ 26°C ~ 28°C
DRY	→ 1°C ~ 2°C lower than the room temperature	DRY	→ 1°C ~ 2°C lower than the room temperature
		HEAT	→ 20°C ~ 24°C

- During **AUTO** Operation, press [3] to select:-
 - Operation with 2°C higher than the standard temperature.
 - Operation with the standard temperature.
 - Operation with 2°C lower than the standard temperature.

● Standard Temperature

Cooling Model		
Indoor temperature	Operation	Standard temperature
23°C	Cooling	25°C
	Soft Dry	22°C

- Once the Automatic Operation is selected, the indoor temperature sensor operates automatically to select the desired operation mode with Cooling or Soft Dry.
- After the operation mode has been selected, the mode does not change.

Heat Pump Model		
Indoor temperature	Operation	Standard temperature
23°C 20°C	Cooling	25°C
	Soft Dry	22°C
	Heating	21°C

- At the beginning of the automatic operation, Heating, Cooling or Soft Dry is automatically selected according to the indoor temperature.
- The operation mode changes every hour, when necessary.

Setting the Fan Speed

- Press [4] to select:-
 - FAN ■■■ - Low Fan Speed
 - FAN ■■■■ - Medium Fan Speed
 - FAN ■■■■■ - High Fan Speed
 - AUTO - Automatic Fan Speed
- The speed of the indoor fan is adjusted automatically according to the operation. The indoor fan stops occasionally during cooling operation.

Setting the Vertical Airflow Direction

- Press [5] or [6] to select:-

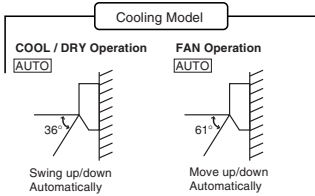

[MANUAL] Five stages of adjustment can be made between 14° ~ 36°.

[MANUAL] Five stages of adjustment can be made between 0° ~ 61°.

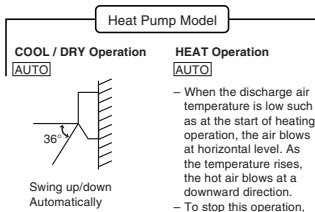

[MANUAL] Five stages of adjustment can be made between 14° ~ 36°.

[MANUAL] Five stages of adjustment can be made between 0° ~ 61°.

Setting the Horizontal Airflow Direction

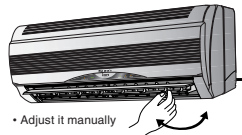

- Use this air conditioner under the following conditions:

Cooling Model				
Unit in °C				
DBT: Dry Bulb Temp	Indoor		Outdoor	
WBT: Wet Bulb Temp	DBT	WBT	DBT	WBT
Maximum Temperature	32	23	43	26
Minimum Temperature	16	11	16	11

Heat Pump Model				
Unit in °C				
DBT: Dry Bulb Temp	Indoor		Outdoor	
WBT: Wet Bulb Temp	DBT	WBT	DBT	WBT
Maximum Temperature-Cooling (Maximum Temperature-Heating)	32 (30)	23 (-)	43 (24)	26 (18)
Minimum Temperature-Cooling (Minimum Temperature-Heating)	16 (16)	11 (-)	16 (-5)	11 (-6)

- Notes**
 - If the unit is not going to be used for an extended period of time, turn off the main power supply. If it is left at the ON position, approximately 2.5 W of electricity will be used even if the indoor unit has been turned off with the remote control.
 - If operation is stopped, then restart immediately, the unit will resume operation only after 3 minutes.

Operation Details

- COOL – Cooling Operation**
 - To set the room temperature at your preference cooling comfort.
- AUTO – Automatic Operation**
 - Sense indoor temperature to select the optimum mode.
 - Temperature is not displayed on the remote control during AUTO operation.
- DRY – Soft Dry Operation**
 - A very gentle Cooling Operation, prior to dehumidification. It does not lower the room temperature.
 - During Soft Dry operation, the indoor fan operates at Low fan speed.
- HEAT – Heating Operation** (for Heat Pump Model only)
 - Heat is obtained from outdoor air to warm up the room. When the outdoor ambient air temperature falls, the heating capacity of the unit might be reduced.
 - Defrosting Operation
 - Depend on the outdoor temperature, the operation occasionally stops to melt the frost on the outdoor unit.
- FAN – Air Circulation Operation** (for Cooling Model only)
 - When the room temperature reaches the set temperature, operation commences at Low airflow volume. It stops when the room temperature drops to 2°C below the set temperature. (It is useful when using a heater).

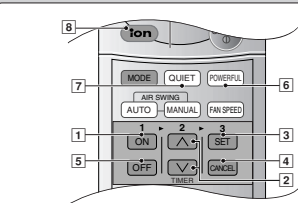

SETTING THE TIMER

Ensure that the current time is correct before setting the timer. The timer cannot be set if the time display is flashing.

- ON-TIMER Operation**
 - To start the air conditioner operation automatically.
 - Press [1] to set the operation.
 - Press [2] to increase or decrease the time.
 - Then press [3].
 - To cancel this operation, press [4].
- OFF-TIMER Operation**
 - To stop the air conditioner operation automatically.
 - Press [5] to set the operation.
 - Press [2] to increase or decrease the time.
 - Then press [3].
 - To cancel this operation, press [4].

- Timer Mode Operation Details**
 - When the ON-Timer is set, operation will start before the actual set time. This is to enable the room temperature reaches the set temperature at the set time.

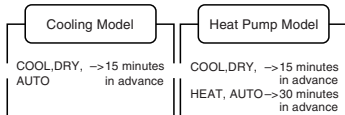

- Once the ON/OFF Timer is set, operation will start/stop at the set time everyday.
- The current time is not displayed when the timers are set.
- When both timers are used together, the TIMER mode indicator on the indoor unit remains lit even when the operation is stopped by the OFF-TIMER.

CONVENIENCE OPERATION

- Powerful Mode Operation**
 - To obtain the set temperature quickly.
 - Press [6].
 - Powerful mode indicator (orange) on the indoor unit will light up.
 - Powerful mode will operate for 15 minutes only.
 - To cancel this operation, press once more.
- Powerful Mode Operation Details**
 - The changes of the temperature and airflow volume are automatic.
 - The remote control display remains unchanged.
 - If operation mode button is pressed, powerful operation will be cancelled.
 - During FAN – Air circulation operation, the powerful operation are not available. (cooling model only)

Powerful Mode Operation	Temperature	Airflow volume
COOL / DRY	3°C lower than set temp.	Super High
HEAT (for Heat Pump model only)	3°C higher than set temp.	Automatic

- Quiet Mode Operation**
 - To provide quiet operation.
 - Press [7].
 - Quiet mode indicator on the indoor unit will light up.
 - To cancel this operation, press once more.
- Operation Details**
 - Air flow sound will reduce during operation.
- Ionizer Mode Operation**
 - Produce negative ion for fresh air.
 - Press [8].
 - Ion mode indicator on the indoor unit will light up.
 - To cancel this operation, press once more.
- Operation Details**
 - Air conditioner ON:
 - Provide negative ion during operation.
 - Air conditioner OFF:
 - Provide negative ion with FAN operation.
 - If blinking, press [8] twice. If still blinking, please call service.



CARE AND MAINTENANCE

■ Cleaning the Indoor Unit and Remote Control

- Wipe gently with a soft, dry cloth.
- Do not use water hotter than 40°C or polishing fluid to clean the unit.

■ Cleaning the Air Filter

(Recommendation:- If the unit is operated in a dusty environment, clean the filters every two weeks, continuous use of this dirty filters will reduce cooling or heating efficiency)

- 1 Remove dirt using a vacuum cleaner.
 - 2 Wash back of the air filter with water.
 - 3 If badly soiled, wash it with soap or a mild household detergent.
 - 4 Let it dry and reinstall it.
Be sure the "FRONT" mark is facing you.
⊗ Damaged air filter.
Consult the nearest authorized dealer.
Part No.: QWD001047.
- Do not use benzene, thinner, scouring powder or clothes soaked in caustic chemical to clean the unit.

■ Cleaning the Front Panel

(Must be removed before washing)

- 1 Raise the front panel higher than the horizontal and pull to remove it.
- 2 Gently wash with water and a sponge.
• Do not press the front panel too hard when washing.
• When use kitchen cleaning fluid (neutral detergent), rinse thoroughly.
• Do not dry the front panel under direct sunlight.
- 3 To fix the front panel, raise the front panel horizontally, match the protruding portion on the indoor unit to the fulcrum and push into place.

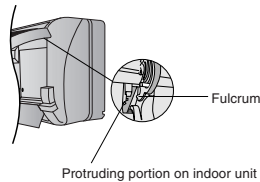

■ Air Purifying Filters

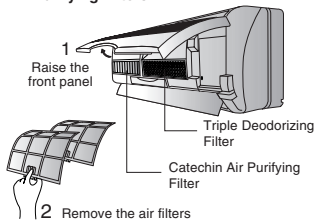

● Triple Deodorizing Filter

- Absorb odours produced by wall paper, construction material and living environment.
- Reusable.
- Vacuum, place under direct sunlight for 6 hours and fit it back in place.
(Recommended: every 6 months)

● Catechin Air Purifying Filter

- The filter is coated with catechin to prevent growth of bacteria and viruses.
- Reusable.
- Vacuum and fit it back in place
(Recommended: every 6 months)

- Recommended to change these filters every 3 years. Do not reuse damaged filters.
Consult the nearest authorized dealer to purchase a new filter.
Catechin Air Purifying Filter No.: CZ-SF70P
Triple Deodorizing Filter No.: CZ-SFD72P

- If you operate the air conditioner with dirty filters:-
- Air is not purified
- Cooling or heating capacity decreases
- Foul odour is emitted

■ Pre-season Inspection

- **Is the discharged air cold/warm?**
Operation is normal if 15 minutes after the start of operation, the difference between the air intake and outlet vents temperature is:-

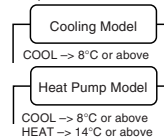

- **Are the air intake or outlet vents of the indoor or outdoor units obstructed?**

- **Are the remote control batteries weak?**
If the remote control display appears weak, replace the batteries.

■ When the Air Conditioner is Not Used for an Extended Period of Time

- 1 To dry the internal parts of the indoor unit, operate the unit for 2 - 3 hours using:-

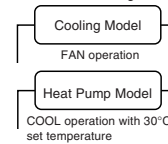

- 2 Turn off the power supply and unplug.
Note: If the unit is not switched off by the remote control, it will start operating when you plug in (because the unit is equipped with Auto Restart Control).
- 3 Remove the remote control batteries.

■ Recommended Inspection

- After used over several seasons, the unit will become dirty and thus decreases the unit's performance. Depending on the operation conditions, a dirty unit may produce odour and dust may pollute dehumidification system. Therefore, a seasonal inspection is recommended in addition to regular cleaning. (Consult an authorized dealer).

HELPFUL INFORMATION

■ Auto Operation Button



● Automatic Operation

- If the remote control fails to function or has been misplaced, press the Auto Operation button to start the Automatic operation.
- The Automatic operation will be activated immediately once the Auto operation button is pressed. However, temperature cannot be adjusted in this operation.
- The power indicator on the indoor unit will blink until the operation mode is selected automatically.
- To cancel this operation, press once more.

● Remote Control Signal Receiving Sound

- To switch off the beep (Signal Receiving Sound), press the Auto Operation button for 10 seconds continuously or longer.
"Beep", "beep" sound will be heard at the tenth seconds.
Note: "Beep" sound will be heard at the fifth seconds;
However please press continuously until you heard "beep", "beep" sound.
- Repeat the above steps if you want to switch on the Signal Receiving Sound.

● (This is for Servicing purposes only)

- Note: If you press this button continuously for 5 to 10 seconds, Test Run operation will be performed. A "beep" sound will be heard at the fifth seconds indicating the Test Run starts to operate.

■ Auto Restart Control

- If power is resumed after a power failure, the operation will restart automatically after 3 - 4 minutes.
- Operation will be restarted automatically under the previous operation mode and airflow direction when power is resumed as the operation is not stopped by the remote control.

■ Timer Setting

- When power failure occurs, the timer setting will be cancelled. Once power is resumed, reset the timer.

■ Thunder and Lightning

- This air conditioner is equipped with a built-in surge protective device. However, in order to further protect your air conditioner from being damaged by abnormally strong lightning activity, you may switch off the main power supply and unplug from power socket.

ENERGY SAVING AND OPERATION HINTS

■ Setting the Temperature

- Approximately 10% of electricity can be saved.
- Set the temperature higher or lower than the desired temperature.

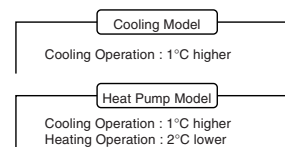

■ Air Filters and Air Purifying Filters

- Clean the air filters every 2 weeks and the Air Purifying Filters every 6 months.
- Dirty filters may reduce cooling or heating efficiency.

■ Keep All Doors and Windows Closed

- Otherwise, cooling or heating performance will be reduced and electricity cost is wasted.

■ Outdoor Unit

- Do not block the air outlet vents. Otherwise, it will lower the cooling or heating performance.

■ Timer Mode

- To prevent wastage of electricity, use Timer when going out.

■ Avoid Direct Sunlight

- Keep curtains or drapes closed to avoid direct sunlight during cooling or heating operation.

TROUBLESHOOTING

■ Normal Operation

Is it okay?	This is the answer
• Air conditioner has been restarted, but does not operate for 3 minutes.	• This is to protect the air conditioner. Wait until the air conditioner begins to operate.
• A sound like water flowing can be heard.	• This is the sound of refrigerant flowing inside the air conditioner.
• It seems that fog is coming out from the air conditioner.	• Condensation occurs when the airflow from the air conditioner cools the room.
• The room has a peculiar odour.	• This may be a damp smell emitted by the wall, carpet, furniture or clothing in the room.
• During Automatic Vertical Airflow setting, indoor fan stops occasionally.	• This is to remove smell emitted by the surroundings.
• The outdoor unit emits water or steam.	• In COOL/DRY operation, moisture in the air condenses into water on the cool surface of outdoor unit piping that causes dripping.
• (For Heat Pump Model only) Operation stops for about 12 minutes during heating (The power indicator blinks).	• This is to melt the frost which has accumulated on the outdoor unit (defrosting operating). This will take no longer than about 12 minutes. Water drips from the outdoor unit. Wait until this operation ends. (the power indicator will light up). (Frost will accumulate on the outdoor unit when the outdoor temperature is low and humidity is high.)
• (For Heat Pump Model only) During heating operation, indoor fan may run at on and off conditions.	• This is to prevent undesired cooling effect during heating operation.

■ Abnormal Operation

Is it okay?	Please check
• The air conditioner does not operate.	• Has the circuit breaker been tripped? • Has the power plug been removed from the wall outlet? • Is the timer being used correctly?
• Air conditioner produces loud noise during operation.	• Is the installation work slanted? • Is the front grille closed properly?
• The air conditioner does not cool or warm effectively.	• Has the temperature been set incorrectly? • Are the filters dirty? • Are the intake or outlet vents of the outdoor unit obstructed? • Are all windows and doors closed?
• Remote control / display doesn't work	• Batteries empty? • Batteries correctly inserted (+) and (-)?

■ Call the Dealer Immediately

If the following conditions occur, turn off and unplug the main power supply, and then call the dealer immediately.

- **Abnormal noise is heard during operation.**
- **Water or foreign material gets into the remote control by mistake.**
- **Water leak from the indoor unit.**
- **Switches or buttons do not operate properly.**
- **The circuit breaker switches off frequently.**
- **Power supply cord and plug become unusually warm.**





10 Installation Instructions

Required tools for Installation Works			
1. Philips screw driver	5. Spanner	9. Gas leak detector	13. Multimeter
2. Level gauge	6. Pipe cutter	10. Measuring tape	14. Torque wrench 18 N.m (1.8 kgf.m) 42 N.m (4.2 kgf.m) 55 N.m (5.5 kgf.m)
3. Electric drill, hole core drill ($\phi 70$ mm)	7. Reamer	11. Thermometer	15. Vacuum pump
4. Hexagonal wrench (4 mm)	8. Knife	12. Megameter	16. Gauge manifold

10.1. Safety Precautions

- Read the following “SAFETY PRECAUTIONS” carefully before installation.
- Electrical work must be installed by a licensed electrician. Be sure to use the correct rating of the power plug and main circuit for the model to be installed.
- The caution items stated here must be followed because these important contents are related to safety. The meaning of each indication used is as below. Incorrect installation due to ignoring of the instruction will cause harm or damage, and the seriousness is classified by the following indications.





 WARNING	This indication shows the possibility of causing death or serious injury.
---	---

 CAUTION	This indication shows the possibility of causing injury or damage to properties only.
---	---

The items to be followed are classified by the symbols:

	Symbol with background white denotes item that is PROHIBITED from doing.
---	--

- Carry out test running to confirm that no abnormality occurs after the installation. Then, explain to user the operation, care and maintenance as stated in instructions. Please remind the customer to keep the operating instructions for future reference.

 WARNING	
1. Engage dealer or specialist for installation. If installation done by the user is defective, it will cause water leakage, electrical shock or fire.	
2. Install according to this installation instruction strictly. If installation is defective, it will cause water leakage, electrical shock or fire.	
3. Use the attached accessories parts and specified parts for installation. Otherwise, it will cause the set to fall, water leakage, fire or electrical shock.	
4. Install at a strong and firm location which is able to withstand the set's weight. If the strength is not enough or installation is not properly done, the set will drop and cause injury.	
5. For electrical work, follow the local national wiring standard, regulation and this installation instruction. An independent circuit and single outlet must be used. If electrical circuit capacity is not enough or defect found in electrical work, it will cause electrical shock or fire.	
6. Use the specified cable (1.5 mm ²) and connect tightly for indoor/outdoor connection. Connect tightly and clamp the cable so that no external force will be acted on the terminal. If connection or fixing is not perfect, it will cause heat-up or fire at the connection.	
7. Wire routing must be properly arranged so that control board cover is fixed properly. If control board cover is not fixed perfectly, it will cause heat-up at connection point of terminal, fire or electrical shock.	
8. When carrying out piping connection, take care not to let air substances other than the specified refrigerant go into refrigeration cycle. Otherwise, it will cause lower capacity, abnormal high pressure in the refrigeration cycle, explosion and injury.	
9. When connecting the piping, do not allow air or any substances other than the specified refrigerant (R410A) to enter the refrigeration cycle. Otherwise, this may lower the capacity, cause abnormally high pressure in the refrigeration cycle, and possibly result in explosion and injury. (Only for models: CS/CU-V7CK, V9CK, V12CK, W7CK, W9CK, W12CK)	
10. <ul style="list-style-type: none"> • When connecting the piping, do not use any existing (R22) pipes and flare nuts. Using such same may cause abnormally high pressure in the refrigeration cycle (piping), and possibly result in explosion and injury. Use only R410A materials. • Thickness of copper pipes used with R410A must be more than 0.8 mm. Never use copper pipes thinner than 0.8 mm. • It is desirable that the amount of residual oil is less than 40 mg/10 m (Only for models: CS/CU-V7CK, V9CK, V12CK, W7CK, W9CK, W12CK). 	
11. Do not modify the length of the power supply cord or use of the extension cord, and do not share the single outlet with other electrical appliances. Otherwise, it will cause fire or electrical shock.	











CAUTION

1. The equipment must be earthed. It may cause electrical shock if grounding is not perfect.
2. Do not install the unit at place where leakage of flammable gas may occur. In case gas leaks and accumulates at surrounding of the unit, it may cause fire. 
3. Carry out drainage piping as mentioned in installation instructions. If drainage is not perfect, water may enter the room and damage the furniture.

ATTENTION

1. Selection of the installation location.
Select a installation location which is rigid and strong enough to support or hold the unit, and select a location for easy maintenance.
2. Power supply connection to the room air conditioner.
Connect the power supply cord of the room air conditioner to the mains using one of the following method.
Power supply point shall be the place where there is ease for access for the power disconnection in case of emergency.
In some countries, permanent connection of this room air conditioner to the power supply is prohibited.
 1. Power supply connection to the receptacle using a power plug.
Use an approved 15A/16A power plug with earth pin for the connection to the socket.
 2. Power supply connection to a circuit breaker for the permanent connection. Use an approved 16A circuit breaker for the permanent connection. It must be a double pole switch with a minimum 3 mm contact gap.
3. Do not release refrigerant.
Do not release refrigerant during piping work for installation, reinstallation and during repairing a refrigeration parts. Take care of the liquid refrigerant, it may cause frostbite.
4. Installation work.
It may need two people to carry out the installation work.
5. Do not install this appliance in a laundry room or other location where water may drip from the ceiling, etc.

Attached accessories

No.	Accessories part	Qty.	No.	Accessories part	Qty.
1	Installation plate 	1	6	Triple Deodorizing filter 	1
2	Installation plate fixing screw 	6	7	Remote Control holder 	1
3	Remote control 	1	8	Remote Control holder fixing screw 	2
4	Battery 	2	9	Drain elbow (Only for models: CU-A7CK, A9CK, W7CK, W9CK, W12CK) 	1
5	Air purifying filter 	1			

Applicable piping kit

CZ-3F5, 7AEN (C7CK, C9CK, A7CK, A9CK, V7CK, V9CK, W7CK, W9CK)

CZ-4F5, 7, 10AN (C12CK, A12CK, V12CK, W12CK)

SELECT THE BEST LOCATION

INDOOR UNIT

- There should not be any heat source or steam near the unit.
- There should not be any obstacles blocking the air circulation.
- A place where air circulation in the room is good.
- A place where drainage can be easily done.
- A place where noise prevention is taken into consideration.
- Do not install the unit near the door way.
- Ensure the spaces indicated by arrows from the wall, ceiling, fence or other obstacles.
- Recommended installation height for indoor unit shall be at least 2.3 m.

OUTDOOR UNIT

- If an awning is built over the unit to prevent direct sunlight or rain, be careful that heat radiation from the condenser is not obstructed.
- There should not be any animal or plant which could be affected by hot air discharged.
- Keep the spaces indicated by arrows from wall, ceiling, fence or other obstacles.
- Do not place any obstacles which may cause a short circuit of the discharged air.
- If piping length is over the common length, additional refrigerant should be added as shown in the table.

Model	Piping size		Common Length (m)	Max. Elevation (m)	Max. Piping Length (m)	Additional Refrigerant (g/m)
	Gas	Liquid				
C7CK/C9CK/	3/8"	1/4"	7.5	5	10	10
C12CK	1/2"	1/4"	7.5	5	15	10
A7CK/A9CK	3/8"	1/4"	7.5	5	10	20
A12CK	1/2"	1/4"	7.5	5	15	20
V7CK/V9CK	3/8"	1/4"	7.5	5	10	10
V12CK	1/2"	1/4"	7.5	5	15	15
W7CK/W9CK	3/8"	1/4"	7.5	5	10	20
W12CK	1/2"	1/4"	7.5	5	15	20

Indoor/Outdoor Unit Installation Diagram

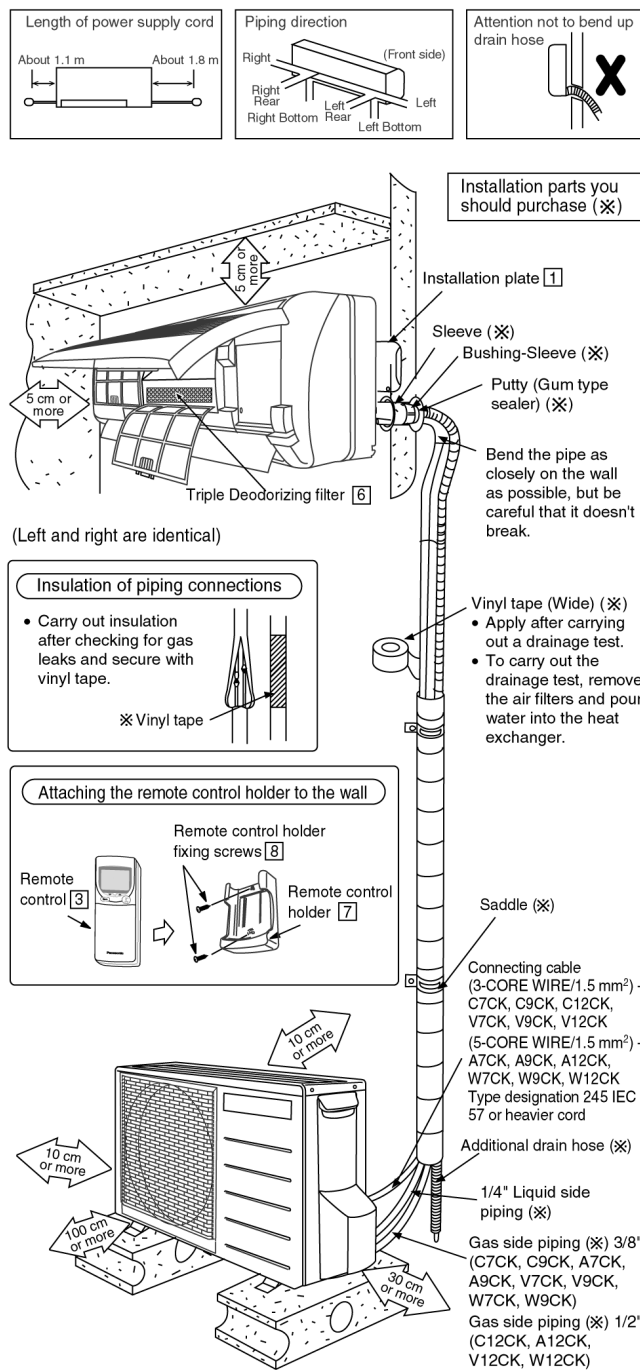

• This illustration is for explanation purposes only. The indoor unit will actually face a different way.

10.2. INDOOR UNIT

10.2.1. SELECT THE BEST LOCATION (Refer to “Select the best location” section)

10.2.2. HOW TO FIX INSTALLATION PLATE

The mounting wall is strong and solid enough to prevent it from the vibration.

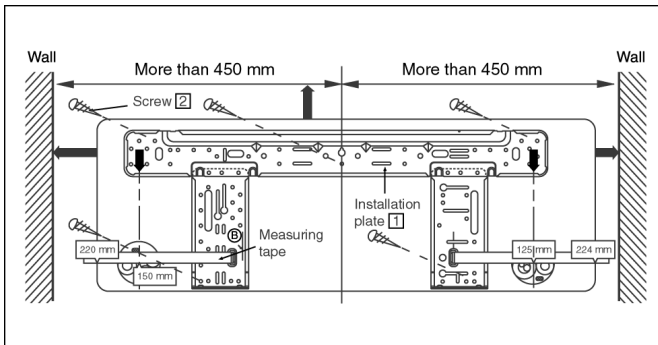

The centre of installation plate should be at more than 450 mm at right and left of the wall.

The distance from installation plate edge to ceiling should more than 67 mm.

From installation plate left edge to unit's left side is 47 mm.

From installation plate right edge to unit's right is 73 mm.

- Ⓑ :
- : For left side piping, piping connection for liquid should be about 14 mm from this line.
 - : For left side piping, piping connection for gas should be about 56 mm from this line.
 - : For left side piping, piping connecting cable should be about 785 mm from this line.

1. Mount the installation plate on the wall with 5 screws or more.

(If mounting the unit on the concrete wall consider using anchor bolts.)

- Always mount the installation plate horizontally by aligning the marking-off line with the thread and using a level gauge.

2. Drill the piping plate hole with $\phi 70$ mm hole-core drill.

- Line according to the arrows marked on the lower left and right side of the installation plate. The meeting point of the extended line is the centre of the hole. Another method is by putting measuring tape at position as shown in the diagram above. The hole centre is obtained by measuring the distance namely 150 mm and 125 mm for left and right hole respectively.
- Drill the piping hole at either the right or the left and the hole should be slightly slanted to the outdoor side.

10.2.3. TO DRILL A HOLE IN THE WALL AND INSTALL A SLEEVE OF PIPING

1. Insert the piping sleeve to the hole.
2. Fix the bushing to the sleeve.
3. Cut the sleeve until it extrudes about 15 mm from the wall.

Caution

When the wall is hollow, please be sure to use the sleeve for tube ass'y to prevent dangers caused by mice biting the connecting cable.

4. Finish by sealing the sleeve with putty or caulking compound at the final stage.

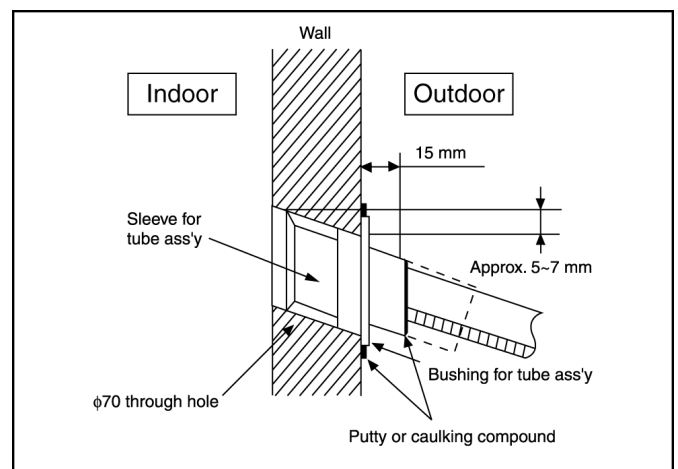

10.2.4. INDOOR UNIT INSTALLATION

1. For the right rear piping

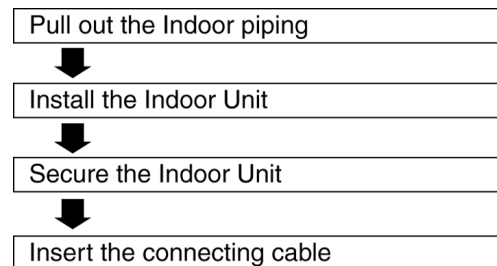

2. For the right and right bottom piping

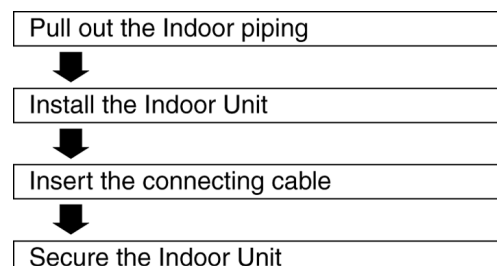

3. For the embedded piping

- Replace the drain hose
- ↓
- Bend the embedded piping
 - Use a spring bender or equivalent to bend the piping so that the piping is not crushed.
- ↓
- Install the Indoor Unit
- ↓
- Cut and flare the embedded piping
 - When determining the dimension of the piping, slide the unit all the way to the left on the installation plate.
 - Refer to the section "Cutting and flaring the piping".
- ↓
- Pull the connecting cable into Indoor Unit
 - The inside and outside connecting cable can be connected without removing the front grille.
- ↓
- Connect the piping
 - Please refer to "Connecting the piping" column in outdoor unit section. (Below steps are done after connecting the outdoor piping and gas-leakage confirmation.)
- ↓
- Insulate and finish the piping
 - Please refer to "Piping and finishing" column of outdoor section and "Insulation of piping connections" column as mentioned in Indoor/Outdoor Unit Installation.
- ↓
- Secure the Indoor Unit

Install the Indoor Unit

Hook the indoor unit onto the upper portion of installation plate (Engage the indoor unit with the upper edge of the installation plate). Ensure the hooks are properly seated on the installation plate by moving in left and right.

Secure the Indoor Unit

1. Tape the extra power supply cord in a bundle and keep it behind the chassis.
 - Ensure that the power supply cord is not clamped in between the unit's hook (2 positions) and installation plate.
2. Press the lower left and right side of the unit against the installation plate until hooks engages with their slots (sound click).

Pull out the piping and drain hose

Move the drain hose near to arrow mark and tape it with piping in a position as mentioned in Fig. below

To take out the unit, push the [PUSH] marking at the bottom unit, and pull it slightly towards you to disengage the hooks from the unit.

(This can be used for left rear piping & left bottom piping also.)

How to keep the cover

In case of the cover is cut, keep the cover at the rear of chassis as shown in the illustration for future reinstallation.

(Left, right and 2 bottom covers for piping)

Exchange the drain hose and the cap

Refer view for left piping installation

Adjust the piping slightly downwards

Insert the connecting cable

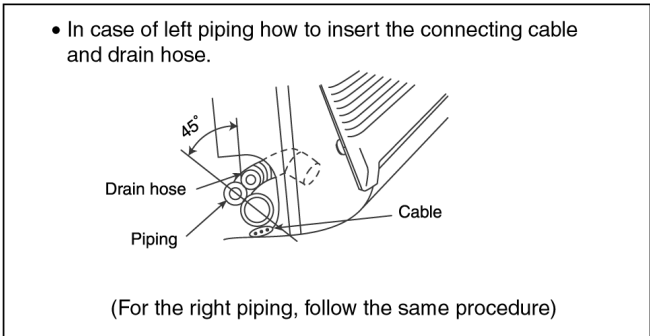
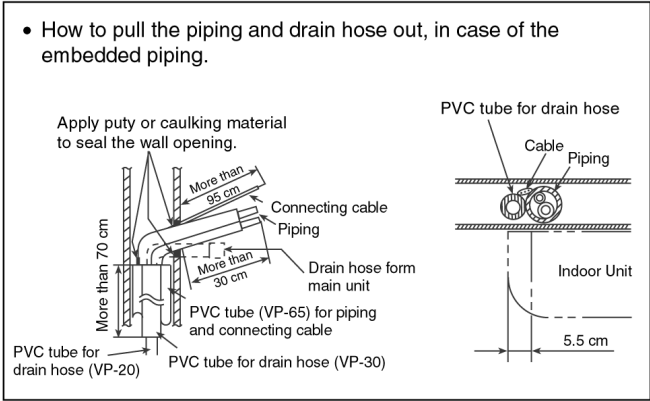

10.2.5. CONNECT THE CABLE TO THE INDOOR UNIT

- The inside and outside connecting cable can be connected without removing the front grille.
- Connecting cable between indoor unit and outdoor unit shall be approved polychloroprene sheathed 3 (C7CK, C9CK, C12CK, V7CK, V9CK, V12CK) or 5 (A7CK, A9CK, A12CK, W7CK, W9CK, W12CK) × 1.5 mm² flexible cord, type designation 245 IEC 57 or heavier cord.
 - Ensure the color of wires of outdoor unit and the terminal Nos. are the same to the indoor's respectively.
 - Earth lead wire shall be longer than the other lead wires as shown in the figure for the electrical safety in case of the slipping out of the cord from the anchorage.

C7CK, C9CK, C12CK, V7CK, V9CK, V12CK

Terminals on the indoor unit	1	2	
Color of wires			
Terminals on the outdoor unit	1	2	

A7CK, A9CK, A12CK, W7CK, W9CK, W12CK

Terminals on the indoor unit	1	2	3	4	
Color of wires					
Terminals on the outdoor unit	1	2	3	4	

- Secure the cable onto the control board with the holder (clammer).

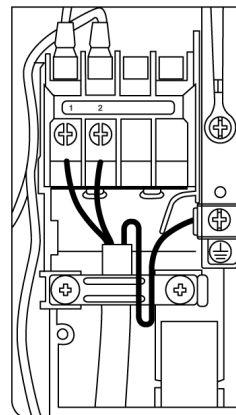

C7CK, C9CK, C12CK, V7CK, V9CK, V12CK

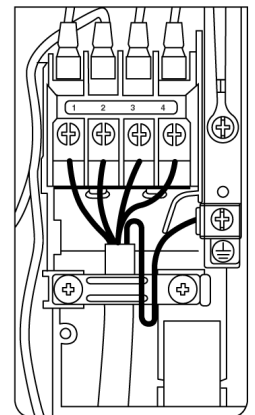

A7CK, A9CK, A12CK, W7CK, W9CK, W12CK

INSTALLATION OF AIR PURIFYING FILTERS

- Open the front panel.
- Remove the air filters.
- Put air purifying filters (left) and triple deodorizing filter (right) into place as shown in illustration below.

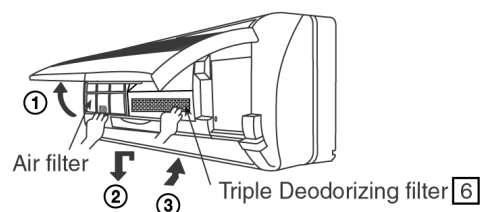

HOW TO TAKE OUT FRONT GRILLE

Please follow the steps below to take out front grille if necessary such as when servicing.

1. Set the vertical airflow direction louver to the horizontal position.
2. Slide down the two caps on the front grille as shown in the illustration below, and then remove the two mounting screws.
3. Pull the lower section of the front grille towards you to remove the front grille.

When reinstalling the front grille, first set the vertical airflow direction louver to the horizontal position and then carry out above steps 2 - 3 in the reverse order.

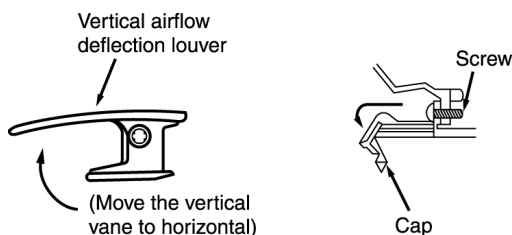

AUTO SWITCH OPERATION

The below operations will be performed by pressing the "AUTO" switch.

1. AUTO OPERATION MODE

The Auto operation will be activated immediately once the Auto Switch is pressed.

2. TEST RUN OPERATION (FOR PUMP DOWN/SERVICING PURPOSE)

The Test Run operation will be activated if the Auto Switch is pressed continuously for more than 5 sec. to below 10 sec.. A "pep" sound will occur at the fifth sec., in order to identify the starting of Test Run operation

3. REMOTE CONTROLLER RECEIVING SOUND ON/OFF

The ON/OFF of Remote Controller receiving sound can be change over by pressing the "AUTO" Switch continuously for 10 sec. and above. A "pep", "pep" sound will occur at the tenth sec., in order to indicate the "ON/OFF" change over of remote control receiving sound.

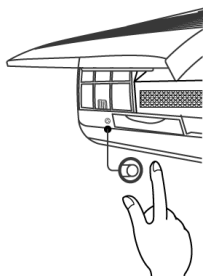

10.3. OUTDOOR UNIT

10.3.1. SELECT THE BEST LOCATION (Refer to "Select the best location" section)

10.3.2. INSTALL THE OUTDOOR UNIT

- After selecting the best location, start installation according to Indoor/Outdoor Unit Installation Diagram.

1. Fix the unit on concrete or rigid frame firmly and horizontally by bolt nut. (ø10 mm).
2. When installing at roof, please consider strong wind and earthquake. Please fasten the installation stand firmly with bolt or nails.

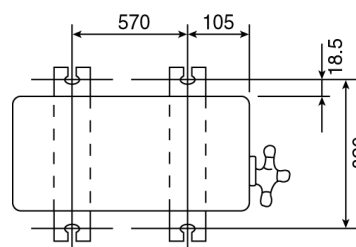

10.3.3. CONNECTING THE PIPING

Connecting The Piping To Indoor Unit

Please make flare after inserting flare nut (locate at joint portion of tube assembly) onto the copper pipe. (In case of using long piping)

Connect the piping

- Align the center of piping and sufficiently tighten the flare nut with fingers.
- Further tighten the flare nut with torque wrench in specified torque as stated in the table.

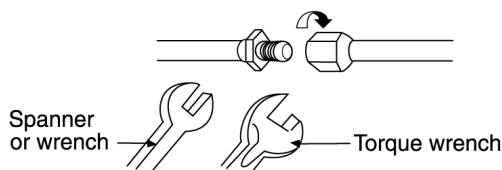

MODEL	Piping size (Torque)	
	Gas	Liquid
C7CK, C9CK, A7CK, A9CK, V7CK, V9CK, W7CK, W9CK	3/8" (42 N.m)	1/4" (18 N.m)
C12CK, A12CK, V12CK, W12CK	1/2" (55 N.m)	1/4" (18 N.m)

Connecting The Piping To Outdoor Unit

Decide piping length and then cut by using pipe cutter. Remove burrs from cut edge. Make flare after inserting the flare nut (located at valve) onto the copper pipe.

Align center of piping to valves and then tighten with torque wrench to the specified torque as stated in the table.

CUTTING AND FLARING THE PIPING

1. Please cut using pipe cutter and then remove the burrs.
2. Remove the burrs by using reamer. If burrs is not removed, gas leakage may be caused.
Turn the piping end down to avoid the metal powder entering the pipe.
3. Please make flare after inserting the flare nut onto the copper pipes.

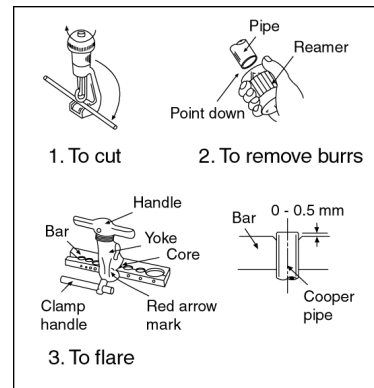

■ Improper flaring ■

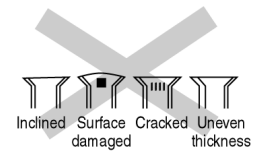

When properly flared, the internal surface of the flare will evenly shine and be of even thickness. Since the flare part comes into contact with the connections, carefully check the flare finish.

10.3.4. (a) EVACUATION OF THE EQUIPMENT (FOR EUROPE & OCEANIA DESTINATION)

WHEN INSTALLING AN AIR CONDITIONER, BE SURE TO EVACUATE THE AIR INSIDE THE INDOOR UNIT AND PIPES in the following procedure.

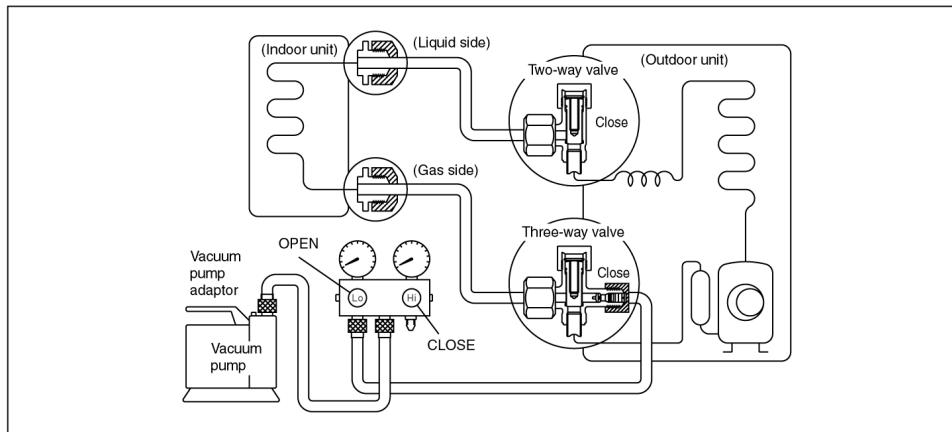

1. Connect a charging hose with a push pin to the Low and High side of a charging set and the service port of the 3-way valve.
 - Be sure to connect the end of the charging hose with the push pin to the service port.
2. Connect the center hose of the charging set to a vacuum pump with check valve, or vacuum pump and vacuum pump adaptor.
3. Turn on the power switch of the vacuum pump and make sure that the needle in the gauge moves from 0 cmHg (0 MPa) to -76 cmHg (-0.1 MPa). Then evacuate the air approximately ten minutes.
4. Close the Low side valve of the charging set and turn off the vacuum pump. Make sure that the needle in the gauge does not move after approximately five minutes.

Note: BE SURE TO FOLLOW THIS PROCEDURE IN ORDER TO AVOID REFRIGERANT GAS LEAKAGE.
5. Disconnect the charging hose from the vacuum pump and from the service port of the 3-way valve.
6. Tighten the service port caps of the 3-way valve at torque of 18 N.m with a torque wrench.
7. Remove the valve caps of both of the 2-way valve and 3-way valve. Position both of the valves to "OPEN" using a hexagonal wrench (4 mm).
8. Mount valve caps onto the 2-way valve and the 3-way valve.
 - Be sure to check for gas leakage.

CAUTION

- If gauge needle does not move from 0 cmHg (0 MPa) to -76 cmHg (-0.1 MPa), in step 3 above take the following measure:
- If the leak stops when the piping connections are tightened further, continue working from step 3.
- If the leak does not stop when the connections are retightened, repair the location of leak.
- Do not release refrigerant during piping work for installation and reinstallation. Take care of the liquid refrigerant, it may cause frostbite.

10.3.5. (b) AIR PURGING OF THE PIPING AND INDOOR UNIT

The remaining air in the Refrigeration cycle which contains moisture may cause malfunction on the compressor.

1. Remove the caps from the 2-way and 3-way valves.
2. Remove the service-port cap from the 3-way valves.
3. To open the valve, turn the valve stem of 2-way valve counter-clockwise approx. 90° and hold it there for ten seconds, then close it.
4. Check gas-leakage of the connecting portion of the pipings.

For the left pipings, refer to item 4(A).

5. To open 2-way valve again, turn the valve stem counter-clockwise until it stops.

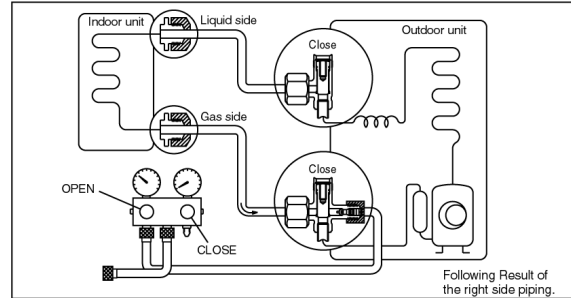
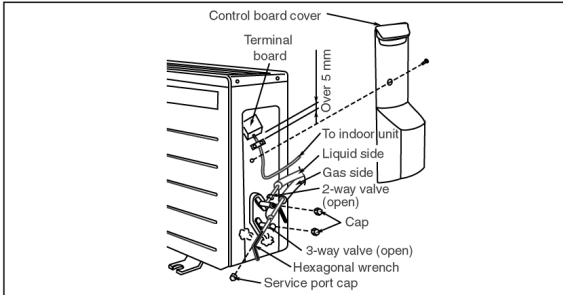

6. To purge the air, push the pin on the service port of 3-way valve for three seconds using with a hexagonal wrench and set it free for one minute.

- Repeat this three times.

7. Set the both 2-way and 3-way valves to open position with the Hexagonal wrench for the unit operation.

No leakage found	Result	Leakage found
↓	• Re-tighten the connecting portion with torque wrenches.	↓
↓	Leakage ceased	Leakage persists
↓	↓	↓
↓	↓	Locate a repair leak
↓	↓	↓
↓	↓	Leakage ceased

4(A). Checking gas leakage for the left piping.

- (1) * Connect the manifold gauge to the service port of 3-way valve.
- * Measure the pressure.

- (2) * Keep it for 5-10 minutes.
- * Ensure that the pressure indicated on the gauge is the same as that of measured during the first time.

10.3.6. CONNECT THE CABLE TO THE OUTDOOR UNIT

1. Remove the control board cover from the unit by loosening the screw.
2. Connecting cable between indoor unit and outdoor unit shall be approved polychloroprene sheathed 3 (C7CK, C9CK, C12CK, V7CK, V9CK, V12CK) or 5 (A7CK, A9CK, A12CK, W7CK, W9CK, W12CK) × 1.5 mm² flexible cord, type designation 245 IEC 57 or heavier cord.

CS/CU-C7CK, C9CK, C12CK, V7CK, V9CK, V12CK			
Terminals on the indoor unit	1	2	⊕
Color of wires			
Terminals on the outdoor unit	1	2	⊕

CS/CU-A7CK, A9CK, A12CK, W7CK, W9CK, W12CK					
Terminals on the indoor unit	1	2	3	4	⊕
Color of wires					
Terminals on the outdoor unit	1	2	3	4	⊕

3. Secure the cable onto the control board with the holder (clammer).
4. Attach the control board cover back to the original position with the screw.

10.3.7. PIPE INSULATION

1. Please carry out insulation at pipe connection portion as mentioned in Indoor/Outdoor Unit Installation Diagram. Please wrap the insulated piping end to prevent water from going inside the piping.
2. If drain hose or connecting piping is in the room (where dew may form), please increase the insulation by using POLY-E FOAM with thickness 6 mm or above.

DISPOSAL OF OUTDOOR UNIT DRAIN WATER

- If a drain elbow is used, the unit should be placed on a stand which is taller than 3 cm.
- If the unit is used in an area where temperature falls below 0°C for 2 or 3 days in succession, it is recommended not to use a drain elbow, for the drain water freezes and the fan will not rotate.

ONLY FOR MODELS:
CU-A7CK, A9CK, A12CK
CU-W7CK, W9CK, W12CK

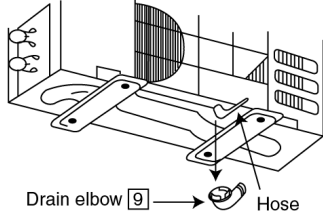

Install the hose at an angle so that the water smoothly flows out.

CHECK THE DRAINAGE

- Open front panel and remove air filters.
(Drainage checking can be carried out without removing the front grille.)
- Pour a glass of water into the drain tray-styrofoam.
- Ensure that water flows out from drain hose of the indoor unit.

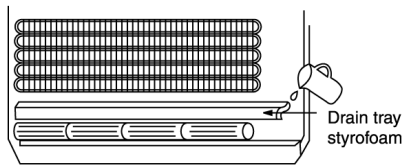

EVALUATION OF THE PERFORMANCE

- Operate the unit at cooling operation mode for fifteen minutes or more.
- Measure the temperature of the intake and discharge air.
- Ensure the difference between the intake temperature and the discharge is more than 8°C.

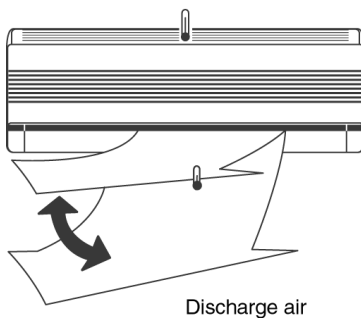

NOTE:

These equipment shall be connected to a suitable mains network with a main impedance less than the following:

CS-A9CKP / CU-A9CKP5: 0.46 Ω
CS-C12CKP / CU-C12CKP5: 0.47 Ω
CS-A12CKP / CU-A12CKP5: 0.47 Ω
CS-V12CKP / CU-V12CKP5: 0.45 Ω
CS-W12CKP / CU-W12CKP5: 0.45 Ω

CHECK ITEMS

- Is there any gas leakage at flare nut connections?
- Has the heat insulation been carried out at flare nut connection?
- Is the connecting cable being fixed to terminal board firmly?
- Is the connecting cable being clamped firmly?
- Is the drainage OK?
(Refer to "Check the drainage" section)
- Is the earth wire connection properly done?
- Is the indoor unit properly hooked to the installation plate?
- Is the power supply voltage complied with rated value?
- Is there any abnormal sound?
- Is the cooling operation normal?
- Is the thermostat operation normal?
- Is the remote control's LCD operation normal?
- Is the air purifying filter installed?

11 Installation and Servicing Air Conditioner Using R410A

11.1. OUTLINE

11.1.1. About R410A Refrigerant

1. Converting air conditioners to R410A

Since it was declared in 1974 that chlorofluorocarbons (CFC), hydro chlorofluorocarbons (HCFC) and other substances pose a destructive danger to the ozone layer in the earth's upper stratosphere (20 to 40 km above the earth), measures have been taken around the world to prevent this destruction.

The R22 refrigerant which has conventionally been used in ACs is an HCFC refrigerant and, therefore, possesses this ozone-destroying potential. International regulations (the Montreal Protocol Ozone-Damaging Substances) and the domestic laws of various countries call for the early substitution of R22 by a refrigerant which will not harm the ozone layer.

- In ACs, the HFC refrigerant which has become the mainstream alternative called R410A. Compared with R22, the pressure of R410A is approximately 1.6 times as high at the same refrigerant temperature, but the energy efficiency is about the same. Consisting of hydrogen (H), fluorine (F) and carbon (C), R410A is an HFC refrigerant. Another typical HFC refrigerant is R407C. While the energy efficiency of R407C is somewhat inferior to that of R410A, it offers the advantage of having pressure characteristics which are about the same as those of R22, and is used mainly in packaged ACs.

2. The characteristics of HFC (R410A) refrigerants

a. Chemical characteristics

The chemical characteristics of R410A are similar to those of R22 in that both are chemically stable, non-flammable refrigerants with low toxicity.

However, just like R22, the specific gravity of R410A gas is heavier than that of air. Because of this, it can cause an oxygen deficiency if it leaks into a closed room since it collects in the lower area of the room. It also generates toxic gas when it is directly exposed to a flame, so it must be used in a well ventilated environment where it will not collect.

Table 1 Physical comparison of R410A and R22

	R410A	R22
Composition (wt%)	R32/R125 (50/50)	R22 (100)
Boiling point (°C)	-51.4	-40.8
Vaporizing pressure (25°C)	1.56 Mpa (15.9 kgf/cm ²)	0.94 Mpa (9.6 kgf/cm ²)
Saturated vapor density	64.0 kg/m ³	44.4 kg/m ³
Flammability	Non-flammable	Non-flammable
Ozone-destroying point (ODP)	0	0.005
Global-warming point (GWP)	1730	1700

b. Compositional change (pseudo-azeotropic characteristics)

R410A is a pseudo-azeotropic mixture comprising the two components R32 and R125. Multi-component refrigerants with these chemical characteristics exhibit little compositional change even from phase changes due to vaporization (or condensation), which means that there is little change in the circulating refrigerant composition even when the refrigerant leaks from the gaseous section of the piping.

Accordingly, R410A can be handled in almost the same manner as the single-component refrigerant R22. However, when charging, because there is a slight change in composition between the gas phase and the liquid phase inside a cylinder or other container, charging should basically begin with the liquid side.

c. Pressure characteristics

As seen in Table 2, the gas pressure of R410A is approximately 1.6 times as high as that of R22 at the same refrigerant temperature, which means that special R410A tools and materials with high-pressure specifications must be used for all refrigerant piping work and servicing.

Table 2 Comparison of R410A and R22 saturated vapor density

Refrigerant Temperature (°C)	Unit: MPa	
	R410A	R22
-20	0.30	0.14
0	0.70	0.40
20	1.35	0.81
40	2.32	1.43
60	3.73	2.33
65	4.15	2.60

d. R410A refrigerating machine oil

Conventionally, mineral oil or a synthetic oil such as alkylbenzene has been used for R22 refrigerating machine oil. Because of the poor compatibility between R410A and conventional oils like mineral oil, however, there is a tendency for the refrigerating machine oil to collect in the refrigerating cycle. For this reason, polyester and other synthetic oils which have a high compatibility with R410A are used as refrigerating machine oil.

Because of the high hygroscopic property of synthetic oil, more care must be taken in its handling than was necessary with conventional refrigerating machine oils. Also, these synthetic oils will degrade if mixed with mineral oil or alkylbenzene, causing clogging in capillary tubes or compressor malfunction. Do not mix them under any circumstances.

11.1.2. Safety Measure When Installing / Receiving Refrigerant Piping

Cause the gas pressure of R410A is approximately 1.6 times as high as that of R22, a mistake in installation or servicing could result in a major accident. It is essential that you use R410a tools and materials, and that you observe the following precautions to ensure safety.

1. Do not use any refrigerant other than R410A in ACs that have been used with R410A.
2. If any refrigerant gas leaks while you are working, ventilate the room. Toxic gas may be generated if refrigerant gas is exposed to a direct flame.
3. When installing or transferring an AC, do not allow any air or substance other than R410A to mix into the refrigeration cycle. If it does, the pressure in the refrigeration cycle can become abnormally high, possibly causing an explosion and/or injury.
4. After finishing the installation, check to make sure there is no refrigerant gas leaking.
5. When installing or transferring an AC, follow the instructions in the installation instructions carefully. Incorrect installation can result in an abnormal refrigeration cycle or water leakage, electric shock, fire, etc.
6. Do not perform any alterations on the AC unit under any circumstances. Have all repair work done by a specialist. Incorrect repairs can result in a water leakage, electric shock, fire, etc.

11.2. TOOL FOR INSTALLING / SERVICING REFRIGERANT PIPING

11.2.1. Necessary Tools

In order to prevent an R410A AC from mistakenly being charged with any other refrigerant, the diameter of the 3-way valve service port on the outdoor unit has been changed. Also, to increase its ability to withstand pressure, the opposing dimensions have been changed for the refrigerant pipe flaring size and flare nut. Accordingly, when installing or servicing refrigerant piping, you must have both the R410A and ordinary tools listed below.

Table 3 Tools for installation, transferring or replacement

Type of work	Ordinary tools	R410A tools
Flaring	Flaring tool (clutch type), pipe cutter, reamer	Copper pipe gauge for clearance Adjustment, flaring tool (clutch type)*1)
Bending, connecting pipes	Torque wrench (nominal diameter 1/4, 3/8, 1/2) Fixed spanner (opposing sides 12 mm, 17 mm, 19 mm) Adjustable wrench, Spring bender	
Air purging	Vacuum pump Hexagonal wrench (opposing sides 4 mm)	Manifold gauge, charging hose, vacuum pump adaptor
Gas leak inspection	Gas leak inspection fluid or soapy water	Electric gas leak detector for HFC refrigerant*2)

*1) You can use the conventional (R22) flaring tool. If you need to buy a new tool, buy the R410A type.

*2) Use when it is necessary to detect small gas leaks.

For other installation work, you should have the usual tools, such as screwdrivers (+,-), a metal-cutting saw, an electrical drill, a hole core drill (65 or 70 dia.), a tape measure, a level, a thermometer, a clamp meter, an insulation tester, a voltmeter, etc.

Table 4 Tools for serving

Type of work	Ordinary tools	R410A tools
Refrigerant charging		Electronic scale for refrigerant charging Refrigerant cylinder Charging orifice and packing for refrigerant cylinder
Brazing (Replacing refrigerating cycle part*1)	Nitrogen blow set (be sure to use nitrogen blowing for all brazing), and brazing), and brazing machine	

*1) Always replace the dryer of the outdoor unit at the same time. The replacement dryer is wrapped in a vacuum pack. Replace it last among the refrigerating cycle parts. Start brazing as soon as you have opened the vacuum pack, and begin the vacuuming operation within 2 hours.

11.2.2. R410A Tools

1. Cooper tube gauge for clearance adjustment
(used when flaring with the conventional flaring tool (clutch type))

- This gauge makes it easy to set the clearance for the copper tube to 1.0-1.5 mm from the clamp bar of the flaring tool.

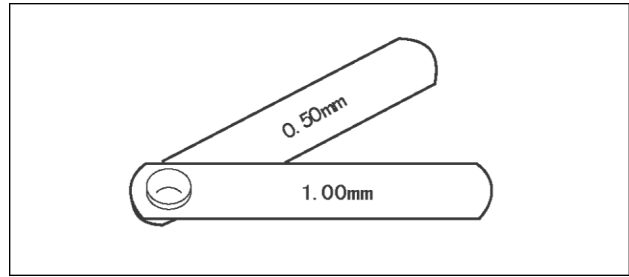

Fig. 1 Copper tube gauge for clearance adjustment

2. Flaring tool (clutch type)

- In the R410A flaring tool, the receiving hole for the clamp bar is enlarged so the clearance from the clamp bar can be set to 0-0.5 mm, and the spring inside the tool is strengthened to increase the strength of the pipe-expanding torque. This flaring tools can also be used with R22 piping, so we recommend that you select it if you are buying a new flaring tool.

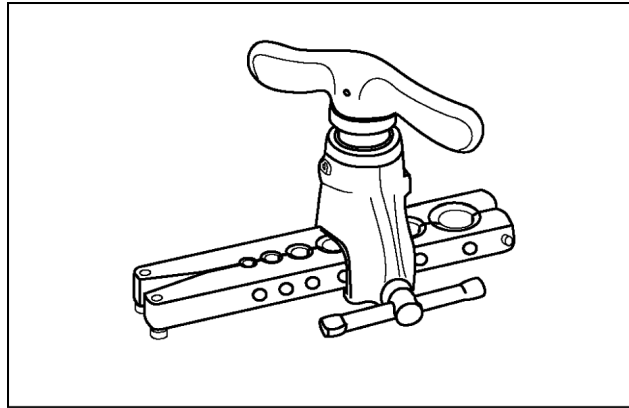

Fig. 2 Flaring tool (clutch type)

3. Torque wrenches

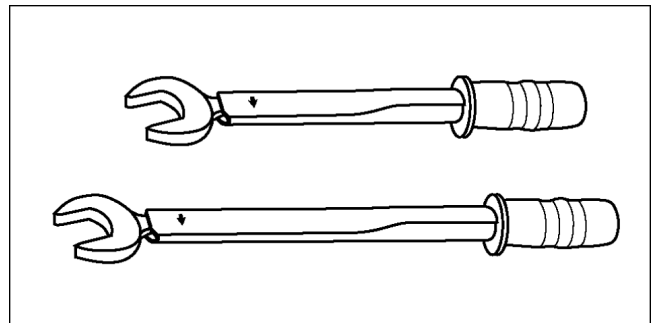

Fig. 3 Torque wrenches

Table 5

	Conventional wrenches	R410A wrenches
For 1/4 (opposite side x torque)	17 mm x 18 N.m (180 kgf.cm)	17 mm x 18 N.m (180 kgf.cm)
For 3/3 (opposite side x torque)	22 mm x 42 N.m (180 kgf.cm)	22 mm x 42 N.m (180 kgf.cm)
For 1/2 (opposite side x torque)	24 mm x 55 N.m (180 kgf.cm)	26 mm x 55 N.m (180 kgf.cm)

4. Manifold gauge

- Because the pressure is higher for the R410A type, the conventional type cannot be used.

Table 6 Difference between R410A and conventional high / low-pressure gauges

	Conventional wrenches	R410A wrenches
High-pressure gauge (red)	-76 cmHg - 35 kgf/cm ³	-0.1 - 5.3 Mpa -76 cmHg - 53 kgf/cm ³
High-pressure gauge (blue)	-76 cmHg - 17 kgf/cm ³	-0.1 - 3.8 Mpa -76 cmHg - 38 kgf/cm ³

- The shape of the manifold ports has been changed to prevent the possibility of mistakenly charging with another type of refrigerant.

Table 7 Difference between R410A and conventional manifold port size

	Conventional gauges	R410A gauges
Port size	7/6 UNF 20 threads	1/2 UNF 20 threads

5. Charging hose

- The pressure resistance of the charging hose has been raised to match the higher pressure of R410A. The hose material has also been changed to suit HFC use, and the size of the fitting has been changed to match the manifold ports.

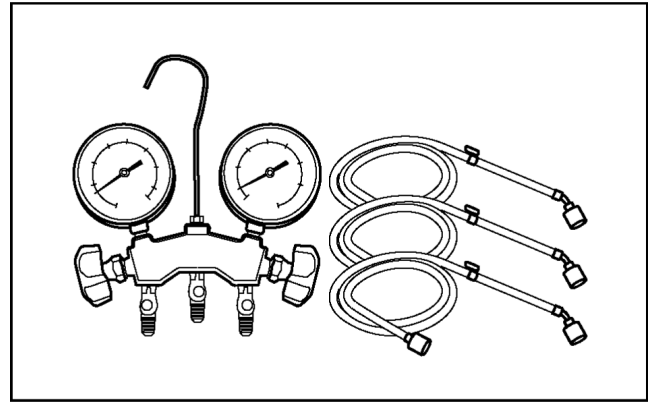

Fig. 4 Manifold gauge charging hose

Table 8 Difference between R410A and conventional charging hoses

		Conventional hoses	R410A hoses
Pressure resistance	Working pressure	3.4 MPa (35 kgf/cm ³)	5.1 MPa (52 kgf/cm ³)
	Bursting pressure	17.2 MPa (175 kgf/cm ³)	27.4 MPa (280 kgf/cm ³)
Material		NBR rubber	HNBR rubber Nylon coating inside

6. Vacuum pump adaptor

- When using a vacuum pump for R410A, it is necessary to install an electromagnetic valve to prevent the vacuum pump oil from flowing back into the charging hose. The vacuum pump adaptor is installed for that purpose. If the vacuum pump oil (mineral oil) becomes mixed with R410A, it will damage the unit.

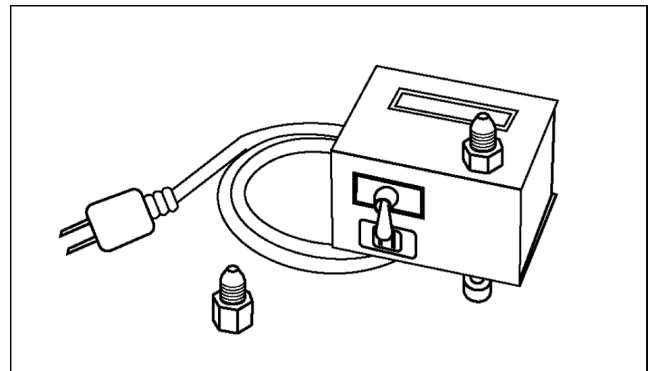

Fig. 5 Vacuum pump adaptor

7. Electric gas leak detector for HFC refrigerant

- The leak detector and halide torch that were used with CFC and HCFC cannot be used with R410A (because there is no chlorine in the refrigerant).
- The present R134a leak detector can be used, but the detection sensitivity will be lower (setting the sensitivity for R134a at 1, the level for R410A will drop to 0.6).
- For detecting small amounts of gas leakage, use the electric gas leak detector for HFC refrigerant. (Detection sensitivity with R410A is about 23 g/year).

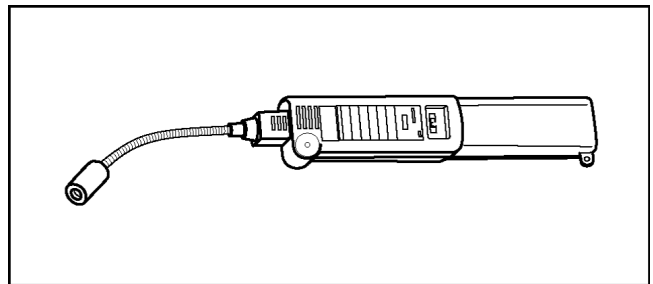

Fig. 6 Electric gas leak detector for HFC refrigerant

8. Electronic scale for refrigerant charging

- Because of the high pressure and fast vaporizing speed of R410A, the refrigerant cannot be held in a liquid phase inside the charging cylinder when charging is done using the charging cylinder method, causing bubbles to form in the measurement scale glass and making it difficult to see the reading. (Naturally, the conventional R22 charging cylinder cannot be used because of the differences in the pressure resistance, scale gradation, connecting port size, etc.)
- The electronic scale has been strengthened by using a structure in which the weight detector for the refrigerant cylinder is held by four supports. It is also equipped with two connection ports, one for R22 (*7/16 UNF, 20 threads) and one for R410A (1/2 UNF, 20 threads), so it can also be used for conventional refrigerant charging.
- There are two types of electronic scales, one for 10-kg cylinders and one for 20-kg cylinders. (The 10-kg cylinder is recommended.)

Refrigerant charging is done manually by opening and closing the valve.

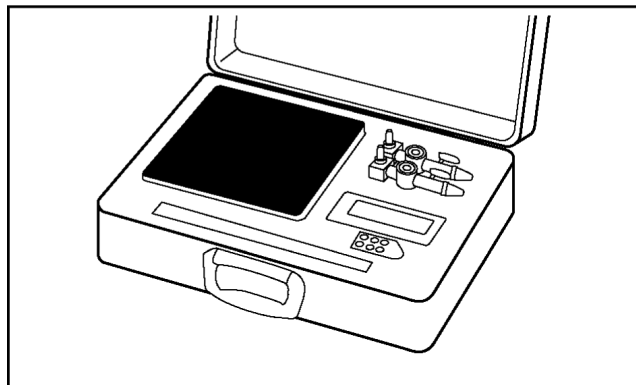

Fig. 7 Electronic scale for refrigerant charging

9. Refrigerant cylinders

- The R410A cylinders are labeled with the refrigerant name, and the coating color of the cylinder protector is pink, which is the color stipulated by ARI of the U.S.
- Cylinder equipped with a siphon tube are available to allow the cylinder to stand upright for liquid refrigerant charging.

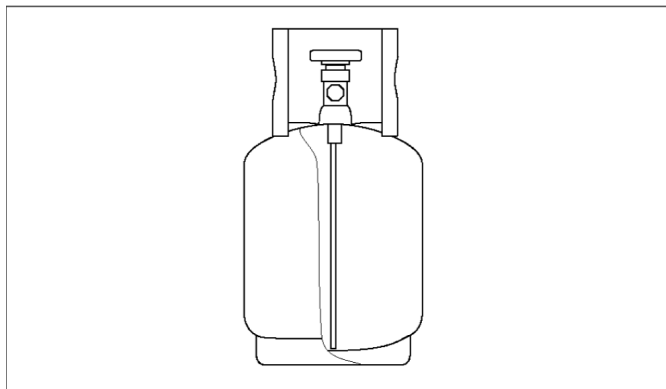

Fig. 8 Refrigerant cylinders

10. Charging orifice and packing for refrigerant cylinders

- The charging orifice must match the size of the charging hose fitting (1/2 UNF, 20 threads).
- The packing must also be made of an HFC-resistant material.

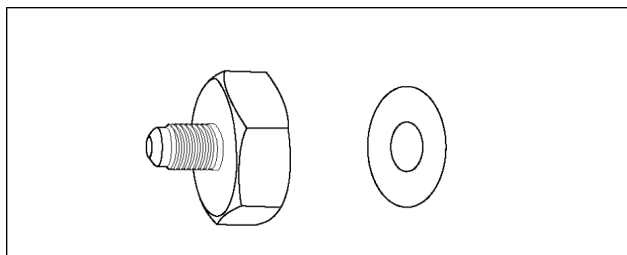

Fig. 9 Charging orifice and packing

11.2.3. R410A Tools Which Are Usable for R22 Models

Table 9 R410A tools which are usable for R22 models

	R410A tools	Usable for R22 models
(1)	Copper tube gauge for clearance adjustment	OK
(2)	Flaring tool (clutch type)	OK
(3)	Manifold gauge	NG
(4)	Charging hose	NG
(5)	Vacuum pump adaptor	OK
(6)	Electric gas leak detector for HFC refrigerant	NG
(7)	Electronic scale for refrigerant charging	OK
(8)	Refrigerant cylinder	NG
(9)	Charging orifice and packing for refrigerant cylinder	NG

11.3. REFRIGERANT PIPING WORK

11.3.1. Piping Materials

It is recommended that you use copper and copper alloy jointless pipes with a maximum oil adherence of 40 mg/10m. Do not use pipes that are crushed, deformed, or discolored (especially the inside surface). If these inferior pipes are used, impurities may clog the expansion valves or capillaries.

Because the pressure of ACs using R410A is higher than those using R22, it is essential that you select materials that are appropriate for these standards.

The thickness of the copper tubing used for R410A is shown in Table 10. Please be aware that tubing with a thickness of only 0.7 mm is also available on the market, but this should never be used.

Table 8 Difference between R410A and conventional charging hoses

Soft pipe		Thickness (mm)	
Nominal diameter	Outside diameter (mm)	R410A	(Reference) R22
1/4	6.35	0.80	0.80
3/8	9.52	0.80	0.80
1/2	12.7	0.80	0.80

11.3.2. Processing and Connecting Piping Materials

When working with refrigerant piping, the following points must be carefully observed: no moisture or dust must be allowed to enter the piping, and there must be no refrigerant leaks.

1. Procedure and precautions for flaring work

a. Cut the pipe

Use a pipe cutter, and cut slowly so the pipe will not be deformed.

b. Remove burrs and clean shavings from the cut surface

If the shape of the pipe end is poor after removing burrs, or if shavings adhere to the flared area, it may lead to refrigerant leaks.

To prevent this, turn the cut surface downward and remove burrs, then clean the surface, carefully.

c. Insert the flare nut (be sure to use the same nut that is used on the AC unit)

d. Flaring

Check the clamp bar and the cleanliness of the copper pipe.

Be sure to use the clamp bar to do the flaring with accuracy. Use either an R410A flaring tool, or a conventional flaring tool. Flaring tools come in different sizes, so be sure to check the size before using. When using a conventional flaring tool, use the copper pipe gauge for clearance adjustment, etc., to ensure the correct A dimension (see Fig. 10)

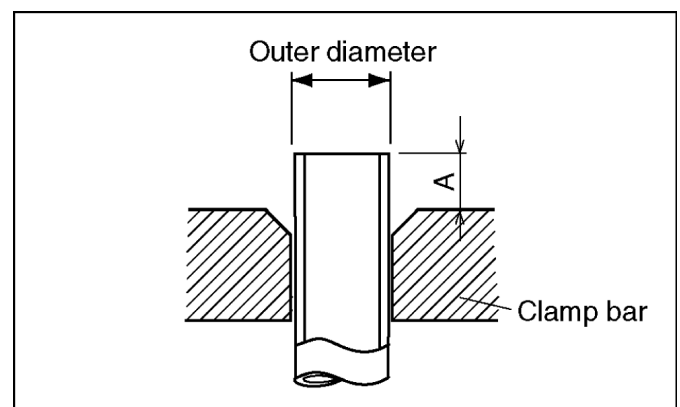

Fig. 10 Flaring dimensions

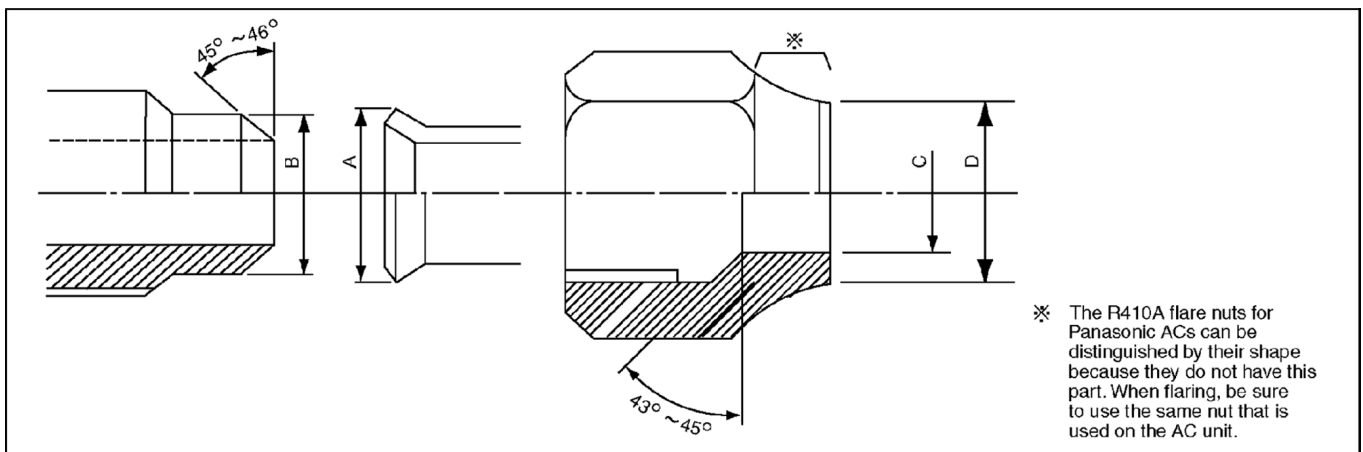

Fig. 11 Relation between the flare nut structure and flaring tool end

Table 11 R410A flaring dimensions

Nominal diameter	Outside diameter (mm)	Wall thickness (mm)	A (mm)		
			R410A flaring tool, clutch type	Conventional flaring tool	
				Clutch type	Wing-nut type
1/4	6.35	0.8	0 - 0.5	1.0 - 1.5	1.5 - 2.0
3/8	9.52	0.8	0 - 0.5	1.0 - 1.5	1.5 - 2.0
1/2	12.70	0.8	0 - 0.5	1.0 - 1.5	2.0 - 2.5

Table 12 R410A flaring dimensions

Nominal diameter	Outside diameter (mm)	Wall thickness (mm)	A (mm)		
			R410A flaring tool, clutch type	Conventional flaring tool	
				Clutch type	Wing-nut type
1/4	6.35	0.8	0 - 0.5	0.5 - 1.0	1.0 - 1.5
3/8	9.52	0.8	0 - 0.5	0.5 - 1.0	1.0 - 1.5
1/2	12.70	0.8	0 - 0.5	0.5 - 1.0	1.5 - 2.0

Table 13 R410A flaring and flare nut dimensions Unit: mm

Nominal diameter	Outside diameter (mm)	Wall thickness (mm)	A +0, -0.4	B dimension	C dimension	D dimension	Flare nut width
1/4	6.35	0.8	9.1	9.2	6.5	13	17
3/8	9.52	0.8	13.2	13.5	9.7	20	22
1/2	12.70	0.8	16.6	16.0	12.9	23	26

Table 14 R410A flaring and flare nut dimensions Unit: mm

Nominal diameter	Outside diameter (mm)	Wall thickness (mm)	A +0, -0.4	B dimension	C dimension	D dimension	Flare nut width
1/4	6.35	0.8	9.0	9.2	6.5	13	17
3/8	9.52	0.8	13.0	13.5	9.7	20	22
1/2	12.70	0.8	16.2	16.0	12.9	20	24

2. Procedure and precautions for flare connection

- Check to make sure there are no scratches, dust, etc., on the flare and union.
- Align the flared surface with the axial center of the union.
- Use a torque wrench, and tighten to the specified torque. The tightening torque for R410A is the same as the conventional torque value for R22. Be careful, because if the torque is too weak, it may lead to a gas leak. If it is too strong, it may split the flare nut or make it impossible to remove the flare nut.

Table 15 R410A tightening torque

Nominal diameter	Outside diameter (mm)	Tightening torque N.m (kgf.cm)	Torque wrench tightening torque N.m (kgf.cm)
1/4	6.35	14 - 18 (140 - 180)	18 (180)
3/8	9.52	33 - 42 (330 - 420)	42 (420)
1/2	12.70	55 (550)	55 (550)

11.3.3. Storing and managing Piping Materials

1. Types of piping and their storage

The following is a general classification of the refrigerant pipe materials used for ACs.

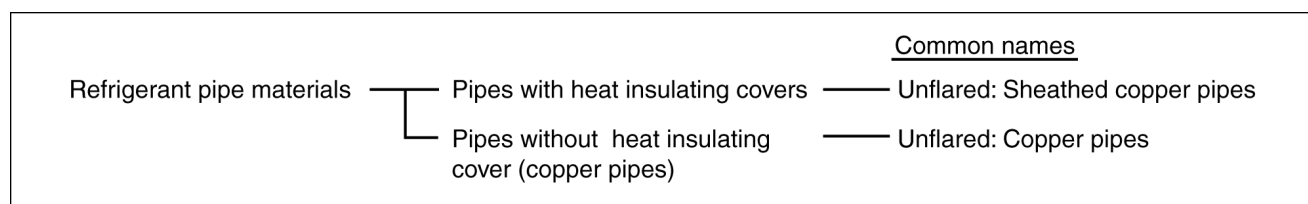

Because the gas pressure of R410A is approximately 1.6 times as high as that of R22, copper pipes with the thickness shown in Table 10, and with minimal impurities must be used. Care must also be taken during storage to ensure that pipes are not crushed, deformed, or scratched, and that no dust, moisture or other substance enters the pipe interior. When storing sheathed copper pipes or plain copper pipes, seal the openings by pinching or taping them securely.

2. Makings and management

a. Sheathed copper pipes and copper-element pipes

When using these pipes, check to make sure that they are the stipulated thickness. For flare nuts, be sure to use the same nut that is used on the AC unit.

b. Copper pipes

Use only copper pipes with the thickness given in table 10, and with minimal impurities. Because the surface of the pipe is exposed, you should take special care, and also take measures such as marking the pipes to make sure they are easily distinguished from other piping materials, to prevent mistaken use.

3. Precautions during refrigerant piping work

Take the following precautions on-site when connecting pipes. (Keep in mind that the need to control the entry of moisture and dust is even more important than in conventional piping).

- a. Keep the open ends of all pipes sealed until connection with AC equipment is complete.
- b. Take special care when doing piping work on rainy days. The entering of moisture will degrade the refrigerating machine oil, and lead to malfunctions in the equipment.
- c. Complete all pipe connections in as short a time as possible. If the pipe must be left standing for a long time after removing the seal, it must be thoroughly purged with nitrogen, or dried with a vacuum pump.

11.4. INSTALLATION, TRANSFERRING, SERVICING

11.4.1. Inspecting Gas Leaks with a Vacuum Pump for New Installations (Using New Refrigerant Piping)

1. From the viewpoint of protecting the global environment, please do not release refrigerant into the atmosphere.
 - a. Connect the projecting side (pin-pushing side) of the charging hose for the manifold gauge to the service port of the 3-way valve. (1)
 - b. Fully open the handle Lo of the manifold gauge and run the vacuum pump. (2) (If the needle of the low-pressure gauge instantly reaches vacuum, re-check step a.)
 - c. Continue the vacuum process for at least 15 minutes, then check to make sure the low-pressure gauge has reached -0.1 MPa (-76 cmHg). Once the vacuum process has finished, fully close the handle Lo of the manifold gauge and stop the vacuum pump operation, then remove the charging hose that is connected to the vacuum pump adaptor. (Leave the unit in that condition for 1-2 minutes, and make sure that the needle of the manifold gauge does not return.) (2) and (3)
 - d. Turn the valve stem of the 2-way valve 90 counter-clockwise to open it, then, after 10 seconds, close it and inspect for a gas leak (4)
 - e. Remove the charging hose from the 3-way valve service port, then open both the 2-way valve and 3-way valve. (1) (4) (Turn the valve stem in the counter-clockwise direction until it gently makes contact. Do not turn it forcefully).
 - f. Tighten the service port cap with a torque wrench (18 N.m (1.8 kgf.m)). (5) Then tighten the 2-way valve and 3-way valve caps with a torque wrench (42 N.m (4.2 kgf.m)) or (55 N.m (5.5 kgf.m)).
 - g. After attaching each of the caps, inspect for a gas leak around the cap area. (5) (6)

Precautions

- Be sure to read the instructions for the vacuum pump, vacuum pump adaptor and manifold gauge prior to use, and follow the instructions carefully.
- Make sure that the vacuum pump is filled with oil up to the designated line on the oil gauge.
- The gas pressure back flow prevention valve on the charging hose is generally open during use. When you are removing the charging hose from the service port, it will come off more easily if you close this valve.

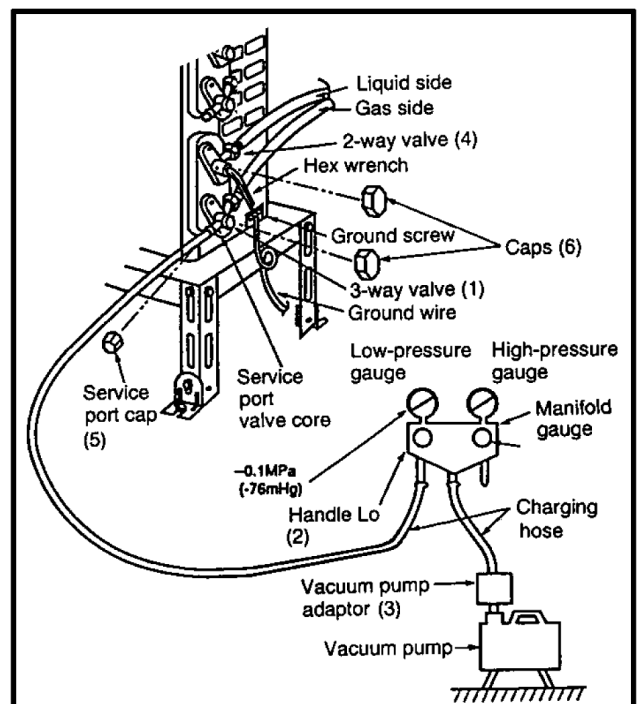

Fig. 12 Vacuum pump air purging configuration

11.4.2. Transferring (Using New Refrigerant Piping)

1. Removing the unit

a. Collecting the refrigerant into the outdoor unit by pumping down

The refrigerant can be collected into the outdoor unit (pumping down) by pressing the TEST RUN button, even when the temperature of the room is low.

- Check to make sure that the valve stems of the 2-way valve and 3-way valve have been opened by turning them counter-clockwise. (Remove the valve stem caps and check to see that the valve stems are fully opened position. Always use a hex wrench (with 4-mm opposing sides) to operate the valve stems.)
- Press the TEST RUN button on the indoor unit, and allow preliminary for 5-6 minutes. (TEST RUN mode)
- After stopping the operation, let the unit sit for about 3 minutes, then close the 2-way valve by turning the valve stem in the clockwise direction.
- Press the TEST RUN button on the indoor unit again, and after 2-3 minutes of operation, turn the valve stem of the 3-way valve quickly in the clockwise direction to close it, then stop the operation.
- Tighten the caps of the 2-way valve and 3-way valve to the stipulated torque.
- Remove the connection pipes (liquid side and gas side).

2. Installing the unit

Install the unit using new refrigerant piping. Follow the instructions in section 4.1 to evacuate the pipes connecting the indoor and outdoor units, and the pipes of the indoor unit, and check for gas leaks.

11.4.3. AC Units Replacement (Using Existing Refrigerant Piping)

When replacing an R410A AC unit with another R410A AC unit, you should re-flare the refrigerant piping. Even though the replacement AC unit uses the R410A, problems occur when, for example, either the AC unit maker or the refrigerating machine oil is different.

When replacing an R22 AC unit with an R410A AC unit, the following checks and cleaning procedures are necessary but are difficult to do because of the chemical characteristics of the refrigerating machine oil (as described in items c) and d) of section 10.1.1.(2)). In this case, you should use new refrigerant piping rather than the existing piping.

1. Piping check

Because of the different pressure characteristics of R22 and R410A, the design pressure for the equipment is 1.6 times different. The wall thickness of the piping must comply with that shown in Table 10, but this is not easy to check. Also, even if the thickness is correct, there may be flattened or bent portions midway through the piping due to sharp curves. Buried sections of the piping also cannot be checked.

2. Pipe cleaning

A large quantity of refrigerating machine oil (mineral oil) adheres to existing pipes due to the refrigeration cycle circulation. If the pipes are used just as they are for the R410A cycle, the capacity will be lowered due to the incompatibility of this oil with the R410A, or irregularities may occur in the refrigeration cycle. For this reason, the piping must be thoroughly cleaned, but this is difficult with the present technology.

11.4.4. Refrigerant Compatibility (Using R410A Refrigerant in R22 ACs and Vice Versa)

Do not operate an existing R22 AC with the new R410A refrigerant. Doing so would result in improper functioning of the equipment or malfunction, and might lead to a major accident such as an explosion in the refrigeration cycle. Similarly, do not operate an R410A AC with R22 refrigerant. The chemical reaction between the refrigerating machine oil used in R410A ACs and the chlorine that is contained in R22 would cause the refrigerating machine oil to degrade and lead to malfunction.

11.4.5. Recharging Refrigerant During Servicing

When recharging is necessary, insert the specified amount of new refrigerant in accordance with the following procedure.

1. Connect the charging hose to the service port of the outdoor unit.
2. Connect the charging hose to the vacuum pump adaptor. At this time, fully open the 2-way valve and 3-way valve.
3. Fully open the handle Lo of the manifold gauge, turn on the power of the vacuum pump and continue the vacuum process for at least one hour.
4. Confirm that the low pressure gauge shows a reading of -0.1 Mpa (-76 cmHg), then fully close the handle Lo, and turn off the vacuum pump. Wait for 1-2 minutes, then check to make sure that the needle of the Low pressure gauge has not returned. See Fig. 13 for the remaining steps of this procedure.

5. Set the refrigerant cylinder onto the electronic scale, then correct the hose the cylinder and to the connection port for the electronic scale. (1)(2)

Precaution:

Be sure to set up the cylinder for liquid charging. If you use a cylinder equipped with a siphon tube, you can charge the liquid without having to turn the cylinder around

6. Remove the charging hose of the manifold gauge from the vacuum pump adaptor, and connect it to the connection port of the electronic scale. (2)(3)
7. Open the valve of the refrigerant cylinder, then open the charging valve slightly and close it. Next, press the check valve of the manifold gauge and purge the air. (2)(4) (Watch the liquid refrigerant closely at this point.)
8. After adjusting the electronic scale to zero, open the charging valve, then open the valve Lo of the manifold gauge and charge with the liquid refrigerant. (2)(5) (Be sure to read the operating instructions for the electronic scale.)
9. If you cannot charge the stipulated amount, operate the unit in the cooling mode while charging a little of the liquid at a time (about 150 g/time as a guideline). If the charging amount is insufficient from one operation, wait about one minute, then use the same procedure to do the liquid charging again.

Precaution:

Never use the gas side to allow a larger amount of liquid refrigerant to be charged while operating the unit.

10. Close the charging valve, and after charging the liquid refrigerant inside the charging hose, fully close the valve Lo of the manifold gauge, and stop the operation of the unit. (2)(5)
11. Quickly remove the charging hose from the service port. (6) If you stop midway through, the refrigerant that is in the cycle will be discharged.
12. After putting on the caps for the service port and operating valve, inspect around the caps for a gas leak. (6)(7)

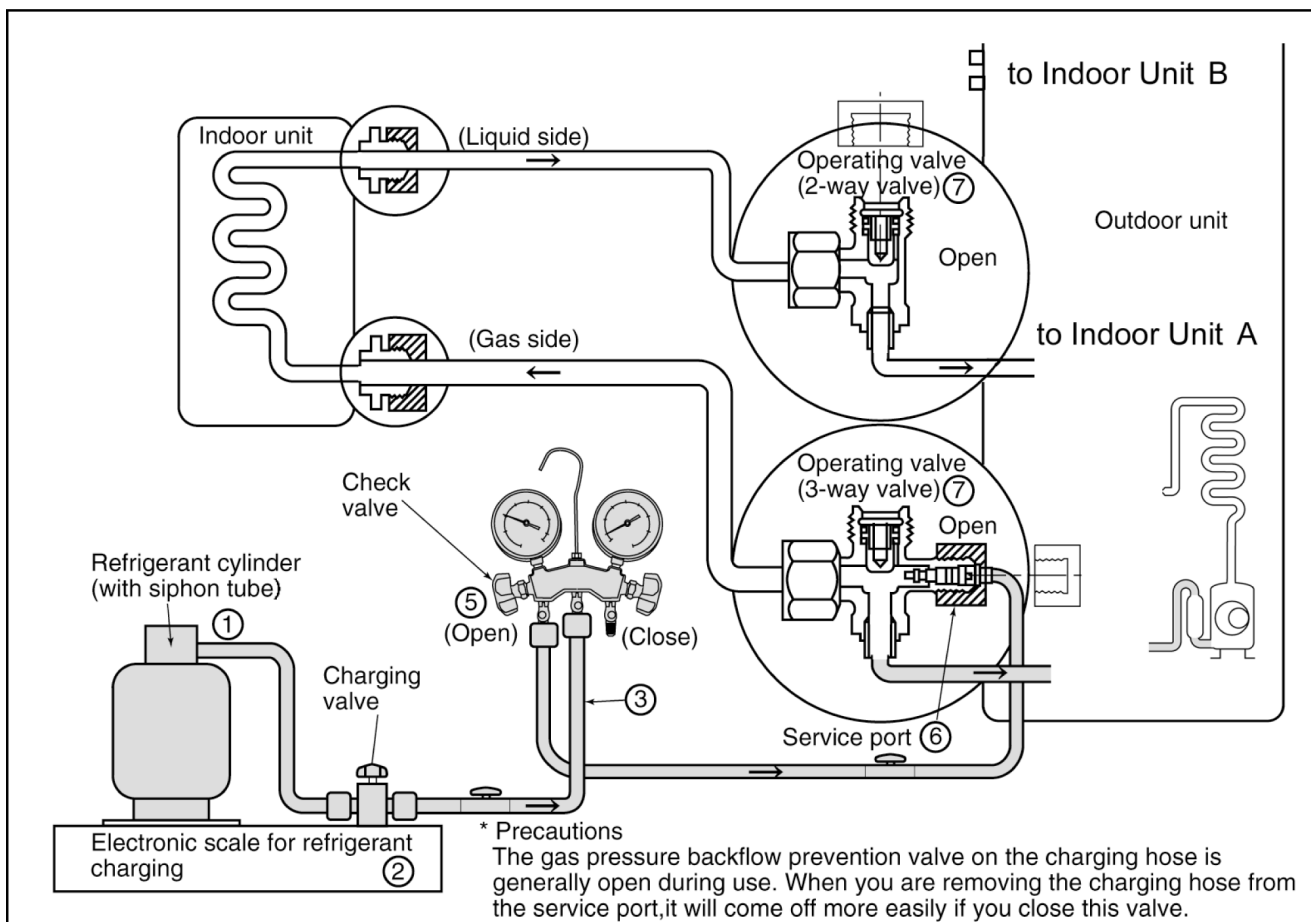

Fig. 13 Re-charging refrigerant

11.4.6. Brazing

As brazing requires sophisticated techniques and experiences, it must be performed by a qualified person.

In order to prevent the oxide film from occurring in the pipe interior during brazing, it is effective to proceed with brazing while letting dry nitrogen gas (N₂) flow.

<Brazing Method for Preventing Oxidation>

1. Attach a reducing valve to the nitrogen gas cylinder.
2. Attach a reducing valve to the nitrogen gas cylinder.
3. Apply a seal onto the clearance between the piping and inserted pipe for the nitrogen gas in order to prevent the nitrogen gas from flowing backward.
4. When the nitrogen gas is flowing, be sure to keep the piping end open.
5. Adjust the flow rate of nitrogen gas so that it is lower than 0.05 m³/h, or 0.02 MPa (0.2 kgf/cm²) by means of the reducing valve.
6. After taking the steps above, keep the nitrogen gas flowing until the piping cools down to a certain extent (i.e. temperature at which pipes are touchable with finger).
7. Completely remove the flux after brazing.

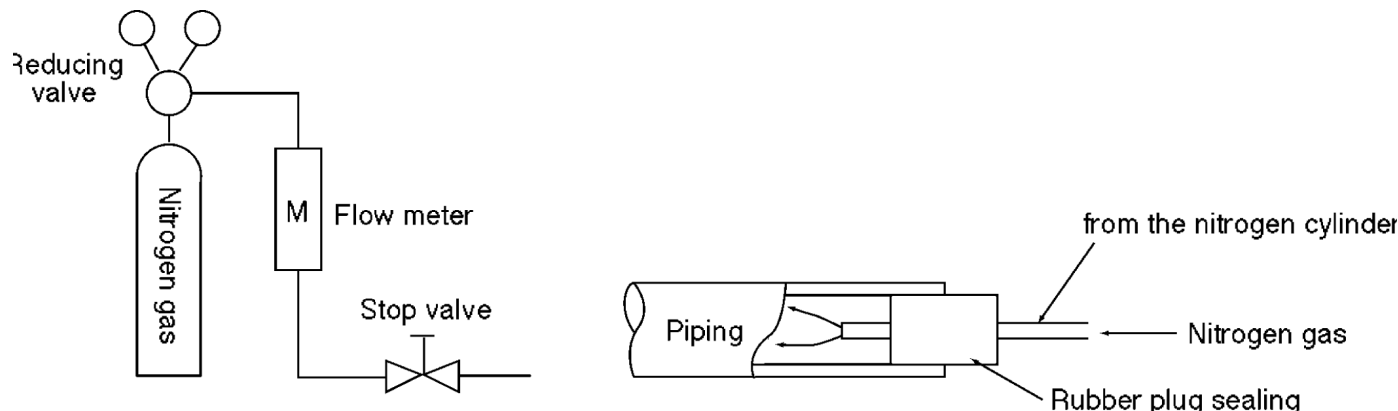

Cautions during brazing

1. General Cautions

- a. The brazing strength should be high as required.
- b. After operation, airtightness should be kept under pressurized condition.
- c. During brazing do not allow component materials to become damaged due to overheating.
- d. The refrigerant pipe work should not become blocked with scale or flux.
- e. The brazed part should not restrict the flow in the refrigerant circuit.
- f. No corrosion should occur from the brazed part.

2. Preventing of Overheating

Due to heating, the interior and exterior surfaces of treated metal may oxidize. Especially, when the interior of the refrigerant circuit oxidizes due to overheating, scale occurs and stays in the circuit as dust, thus exerting a fatally adverse effect. So, make brazing at adequate brazing temperature and with minimum of heating area.

3. Overheating Protection

In order to prevent components near the brazed part from overheating damaged or quality deterioration due to flame or heat, take adequate steps for protection such as (1) by shielding with a metal plate, (2) by using a wet cloth, and (3) by means of heat absorbent.

4. Movement during Brazing

Eliminate all vibration during brazing to protect brazed joints from cracking and breakage.

5. Oxidation Preventative

In order to improve the brazing efficiency, various types of antioxidant are available on the market. However, the constituents of these are widely varied, and some are anticipated to corrode the piping materials, or adversely affect HFC refrigerant, lubricating oil, etc. Exercise care when using an oxidation preventative.

11.4.7. Servicing Tips

The drier must also be replaced whenever replacing the refrigerant cycle parts. Replacing the refrigerant cycle parts first before replacing the drier. The drier is supplied in a vacuum pack. Perform brazing immediately after opening the vacuum pack, and then start the vacuum within two hours. In addition, the drier also needs to be replaced when the refrigerant has leaked completely.

12 Servicing Information

Caution:

- Pb free solder has a higher melting point than standard solder; Typically the melting point is 50 - 70°F (30 - 40°C) higher. Please use a high temperature soldering iron. In case of the soldering iron with temperature control, please set it to 700 ± 20°F (370 ± 10°C).
- Pb free solder will tend to splash when heated too high (about 1100° F/600°C).

12.1. Indoor Electronic Controllers Removal Procedures

1. The Electronic Controller, a Signal Receiver and an Indicator (Fig. 3) can be seen by the below steps:

- Remove the 2 caps and 2 screws at the bottom of the Front Grille. (Fig. 1)
- Remove the Front Grille by releasing the 2 hooks at the top of the Front Grille. (Fig. 1)
- Remove the Control Board Cover by releasing the 2 tabs at left, 1 tab on top and 1 tab at right side of the Control Board Cover. (Fig. 2)

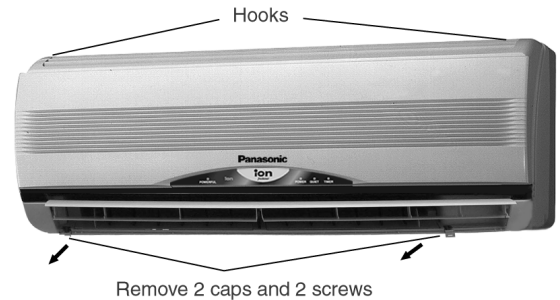

Fig. 1



Fig. 2

2. To remove the Electronic Controller:

- Release the Particular Piece. (Fig. 3)
- Release the hook that hold the Electronic Controller. (Fig. 3)

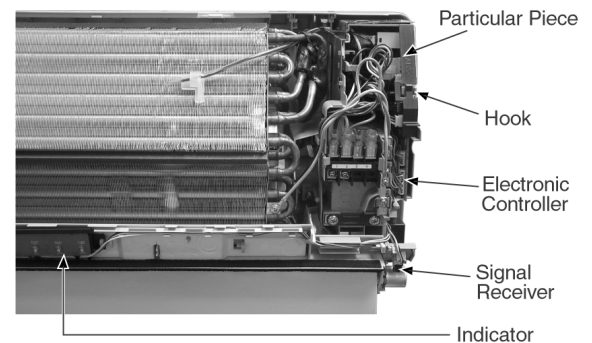

Fig. 3

12.2. Indoor Fan Motor and Cross Flow Fan Removal Procedures

- Remove the Control Board by:-
 - Releasing CN-REC/DISP connectors. (Fig. 4)
 - Releasing CN-FM connectors. (Fig. 4)
 - Releasing CN-ION connector. (Fig. 4)
 - Releasing CN-STM connector. (Fig. 4)
 - Removing the Earth Wire screw. (Fig. 4)
 - Releasing the Intake Air Sensor. (Fig. 4)
 - Releasing the Piping Sensor. (Fig. 4)

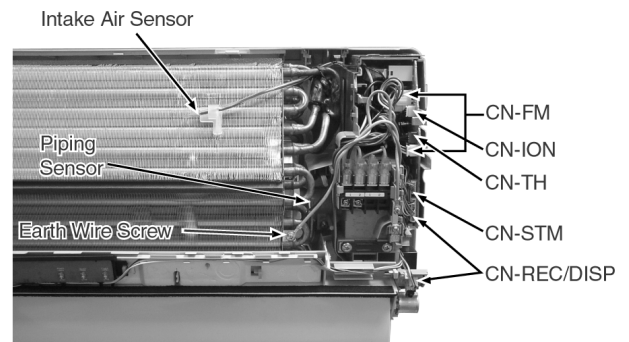

Fig. 4

- Pulling out the Drain Hose from outlet to remove the Discharge Grille. (Fig. 5)
- Removing the right and left screws. (Fig. 5)
- Then remove the Control Board by pressing down the hook at the left and pushing up the right hook. (Fig. 5)
- Releasing connector lead wire lonizer. (Fig. 5)

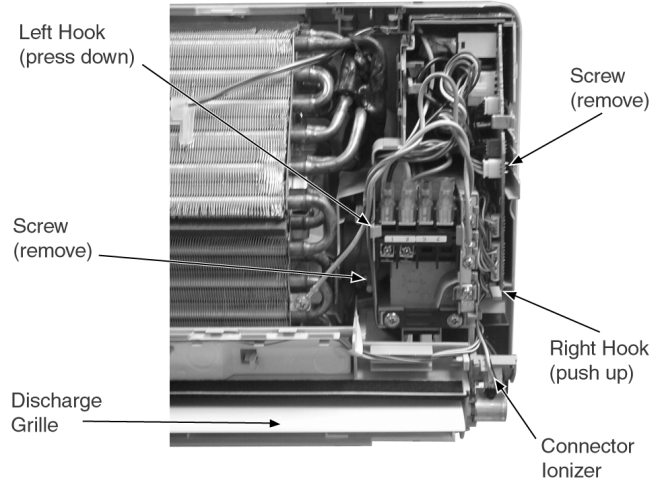

Fig. 5

- Release the Fan Motor leadwire by pressing the hook at the center of the connector. (Fig. 6)

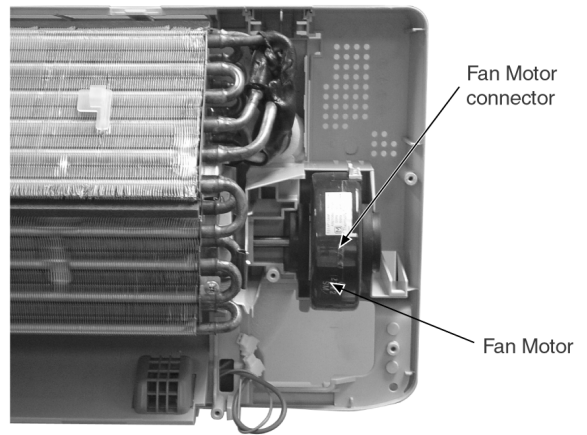

Fig. 6

- Remove the screw at the Cross Flow Fan. (Fig. 7)
- REMINDER - To reinstall the Fan Motor, adjust the connector of the Fan Motor as shown in the Fig. 7.

To reinstall the Fan Motor, please adjust the connector location is positioned 45° with Fan Motor before fixing Control Board Complete.

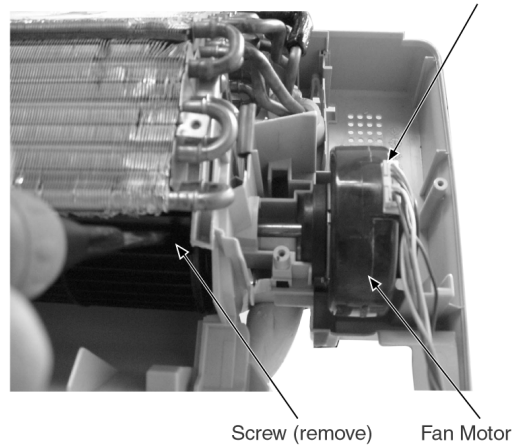

Fig. 7

- Remove the screws at the left of the Evaporator. (Fig. 8)

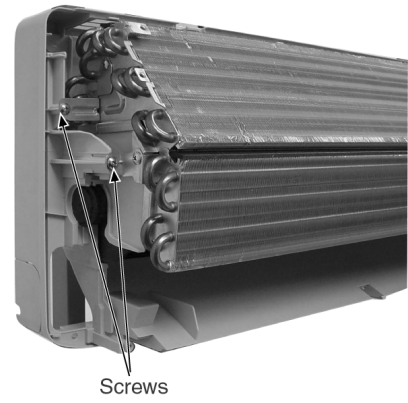

Fig. 8

- Remove the Bearing. (Fig. 9)
- Push up the Evaporator and pull out the Cross Flow Fan from shaft. By then, Fan Motor can be taken out. (Fig. 9)

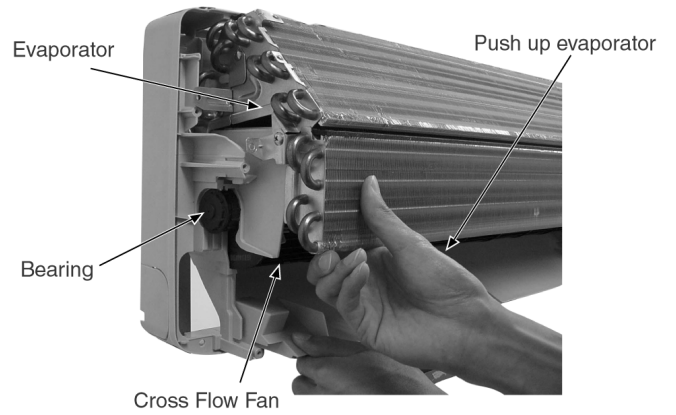

Fig. 9

• Remote Control Reset

When the batteries are inserted for the first time, or the batteries are replaced, all the indications will blink and the remote control might not work.

If this happen, remove the cover of the remote control and you will find a resetting terminal, and by shorting it with a minus screwdriver, it will return to normal.



• Changing the wireless remote control transmission code

When two indoor units are installed in the same room, in order to prevent operating errors caused by using two remote controls, cut a jumper wire at the remote control printed circuit board (J - A) and cut a jumper wire at the indoor printed circuit board (JX4). It is possible to select from 4 types of transmission codes including one at time of delivery condition (0).

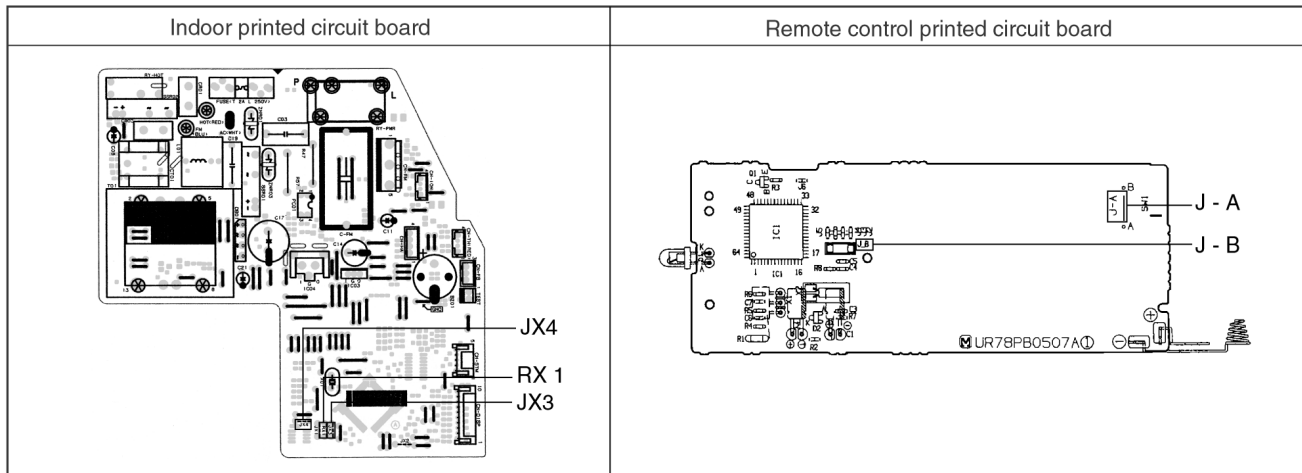

	Remote control printed circuit board		Indoor printed circuit board			Note
	J - A	J - B	JX3	JX4	RX 1	
0	SHORT	OPEN	SHORT	SHORT	—	At product delivery
1	OPEN	OPEN	SHORT	OPEN	—	
2	SHORT	SHORT	OPEN	OPEN	10 KΩ	
3	OPEN	SHORT	SHORT	OPEN	10 KΩ	

13 Troubleshooting Guide

13.1. Refrigeration cycle system

In order to diagnose malfunctions, make sure that there are no electrical problems before inspecting the refrigeration cycle. Such problems include insufficient insulation, problem with the power source, malfunction of a compressor and a fan.

The normal outlet air temperature and pressure of the refrigeration cycle depends on various conditions, the standard values for them are shown in the table to the right.

Normal Pressure and Outlet Air Temperature (Standard)

	Gas pressure Mpa (kg/cm ² G)	Outlet air temperature (°C)
Cooling Mode	0.4 ~ 0.6 (4 ~ 6)	12 ~ 16
Heating Mode	1.5 ~ 2.1 (15 ~ 21)	36 ~ 45

* Condition: Indoor fan speed; High
Outdoor temperature 35°C at the cooling mode and 7°C at the heating mode

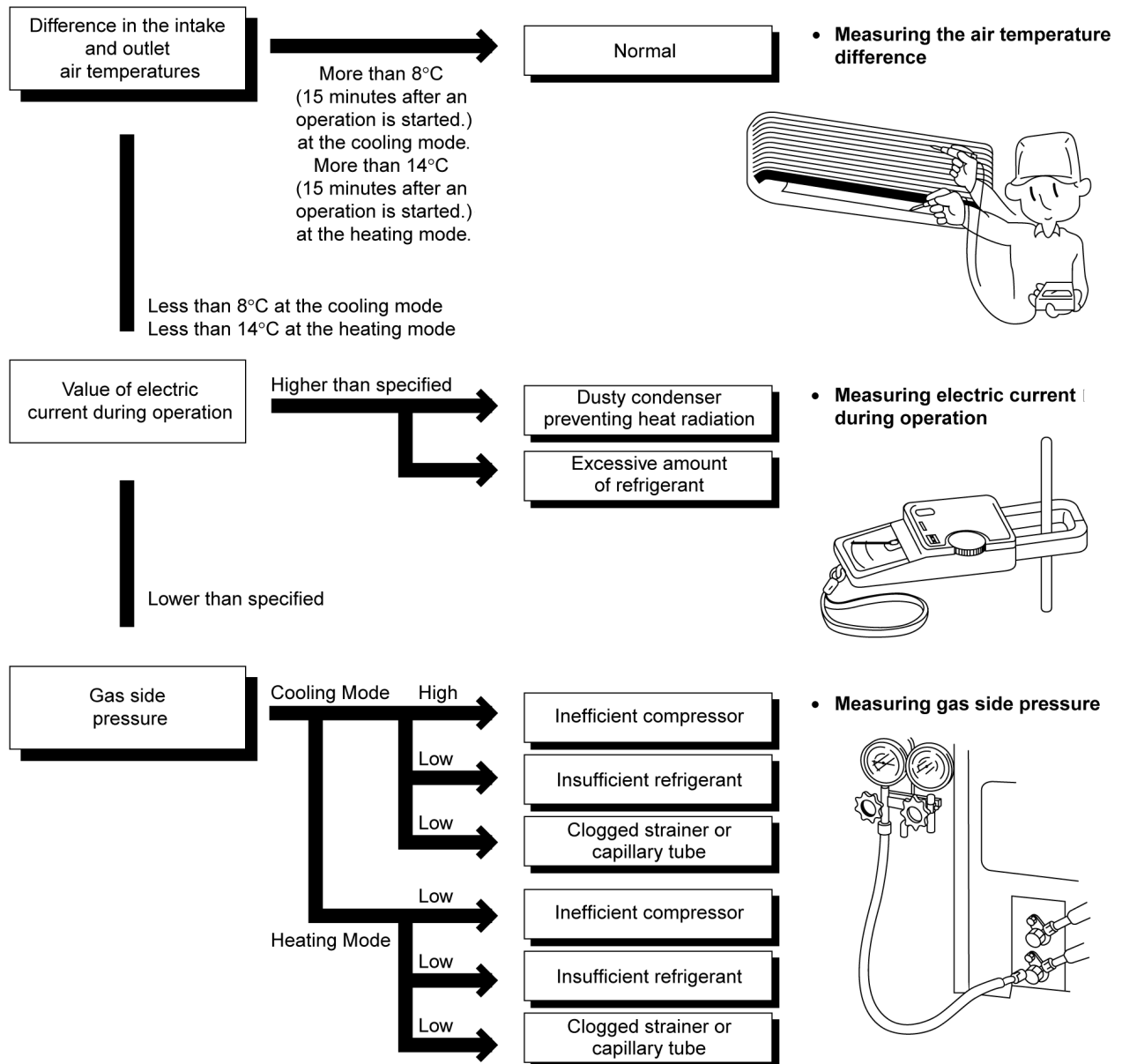

13.1.1. Relationship between the condition of the air conditioner and pressure and electric current

Condition of the air conditioner	Cooling Mode			Heating Mode		
	Low Pressure	High Pressure	Electric current during operation	Low Pressure	High Pressure	Electric current during operation
Insufficient refrigerant (gas leakage)						
Clogged capillary tube or Strainer						
Short circuit in the indoor unit						
Heat radiation deficiency of the outdoor unit						
Inefficient compression						

- Carry out the measurements of pressure, electric current, and temperature fifteen minutes after an operation is started.

13.1.2. Diagnosis methods of a malfunction of a compressor and 4-way valve

Nature of fault	Symptom
Insufficient compressing of a compressor	<ul style="list-style-type: none"> • Electric current during operation becomes approximately 20% lower than the normal value. • The discharge tube of the compressor becomes abnormally hot (normally 70 to 90°C). • The difference between high pressure and low pressure becomes almost zero.
Locked compressor	<ul style="list-style-type: none"> • Electric current reaches a high level abnormally, and the value exceeds the limit of an ammeter. In some cases, a breaker turns off. • The compressor is a humming sound.
Insufficient switches of the 4-way valve	<ul style="list-style-type: none"> • Electric current during operation becomes approximately 80% lower than the normal value. • The temperature different between from the discharge tube to the 4-way valve and from suction tube to the 4-way valve becomes almost zero.

14 Technical Data

■ Thermostat characteristics

CS-W7CK / CS-W9CK / CS-W12CK

• Cooling

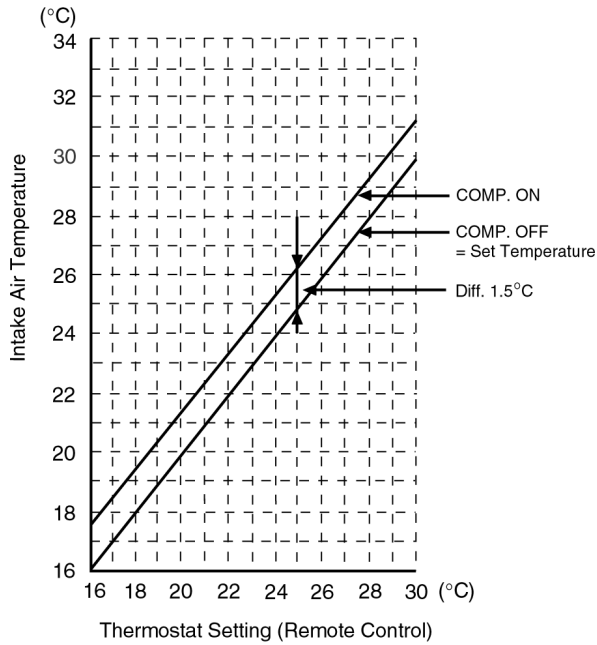

• Soft Dry

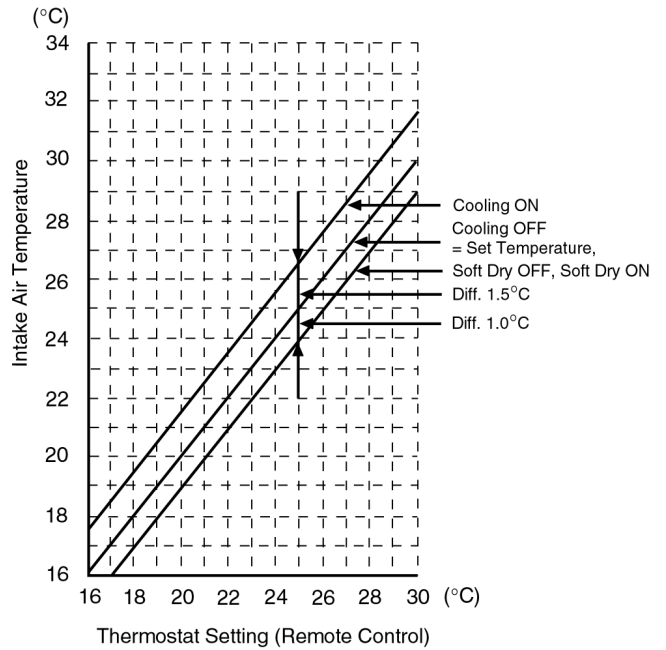

• Heating

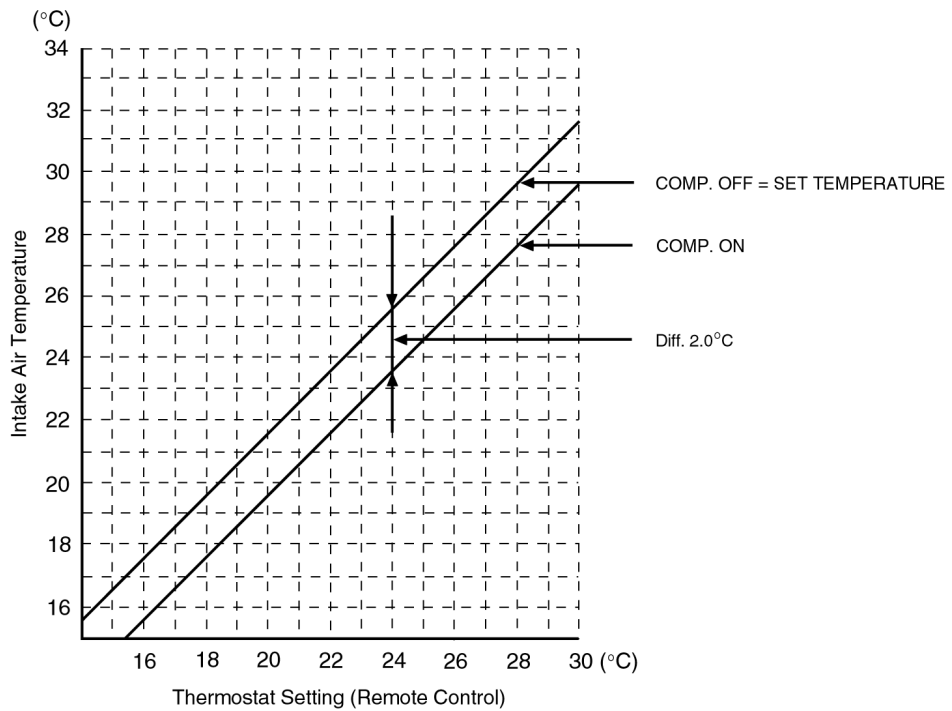

■ Sensible Capacity Chart

• CS-W7CK

230V Indoor wet bulb temp.	Outdoor Temp. (°C)											
	30			35			40			46		
	TC	SHC	IP	TC	SHC	IP	TC	SHC	IP	TC	SHC	IP
17.0°C	2.36	1.79	0.60	2.21	1.72	0.65	2.05	1.65	0.70	1.87	1.57	0.75
19.0°C				2.38		0.66						
19.5°C	2.59	1.87	0.62	2.42	1.80	0.66	2.25	1.73	0.71	2.05	1.65	0.76
22.0°C	2.83	1.94	0.63	2.64	1.87	0.67	2.46	1.80	0.72	2.23	1.72	0.78

• CS-W9CK

230V Indoor wet bulb temp.	Outdoor Temp. (°C)											
	30			35			40			46		
	TC	SHC	IP	TC	SHC	IP	TC	SHC	IP	TC	SHC	IP
17.0°C	2.88	2.18	0.78	2.69	2.09	0.84	2.50	2.01	0.90	2.27	1.91	0.97
19.0°C				2.90		0.85						
19.5°C	3.16	2.28	0.79	2.95	2.19	0.85	2.75	2.11	0.91	2.50	2.01	0.98
22.0°C	3.44	2.37	0.81	3.22	2.28	0.87	2.99	2.20	0.93	2.72	2.09	1.00

• CS-W12CK

230V Indoor wet bulb temp.	Outdoor Temp. (°C)											
	30			35			40			46		
	TC	SHC	IP	TC	SHC	IP	TC	SHC	IP	TC	SHC	IP
17.0°C	3.71	2.81	1.01	3.47	2.70	1.08	3.22	2.59	1.16	2.93	2.46	1.25
19.0°C				3.74		1.10						
19.5°C	4.07	2.94	1.03	3.81	2.83	1.10	3.54	2.72	1.18	3.22	2.59	1.27
22.0°C	4.44	3.05	1.05	4.15	2.94	1.12	3.86	2.83	1.20	3.51	2.70	1.30

TC - Total Cooling Capacity (kW)
 SHC - Sensible Heat Capacity (kW)
 IP - Input Power (kW)

Indoor 27°C/19°C
 Outdoor 35°C/24°C

■ Operation characteristics

CS-W7CK / CU-W7CK

● Cooling Characteristic

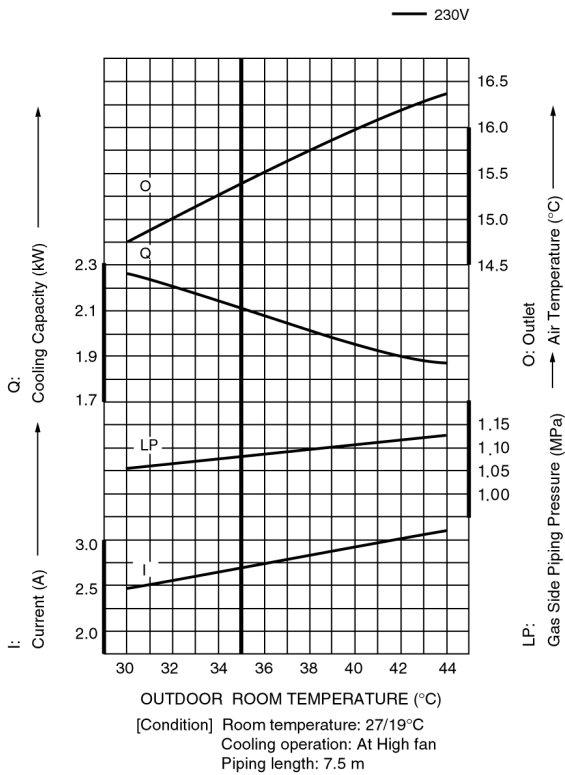

● Piping Length Characteristic (Cooling)

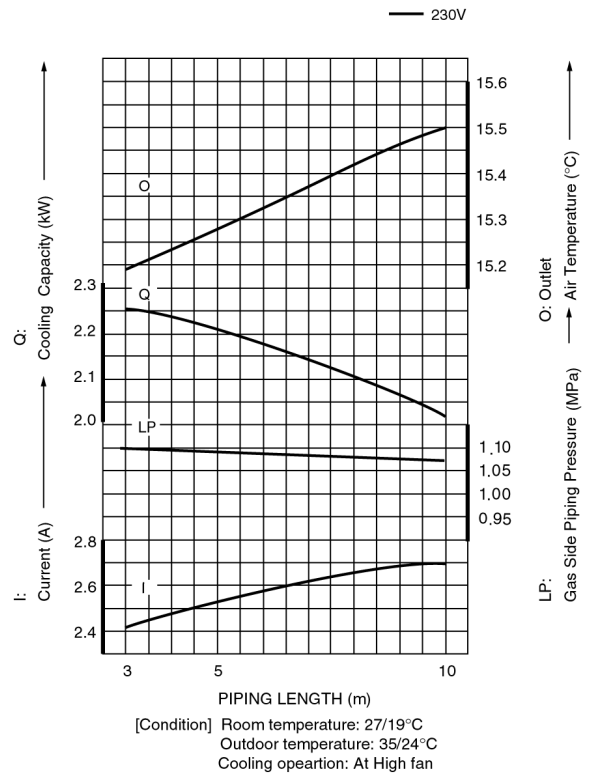

● Heating Characteristic

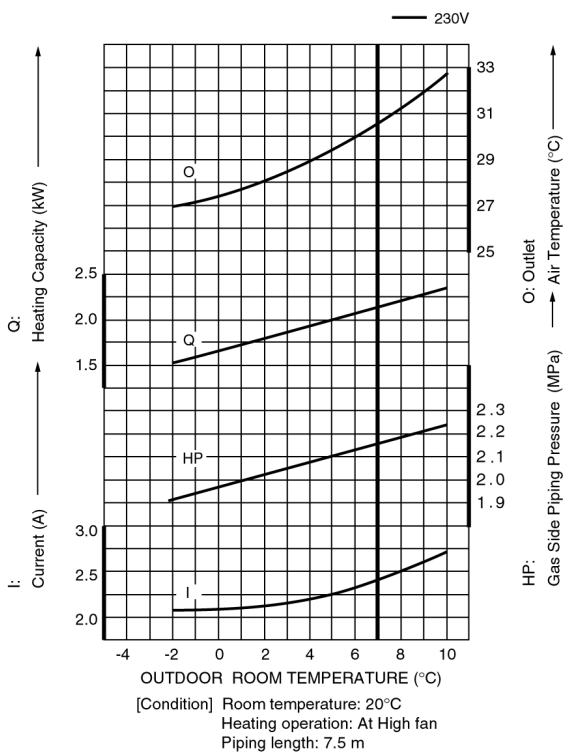

● Piping Length Characteristic (Heating)

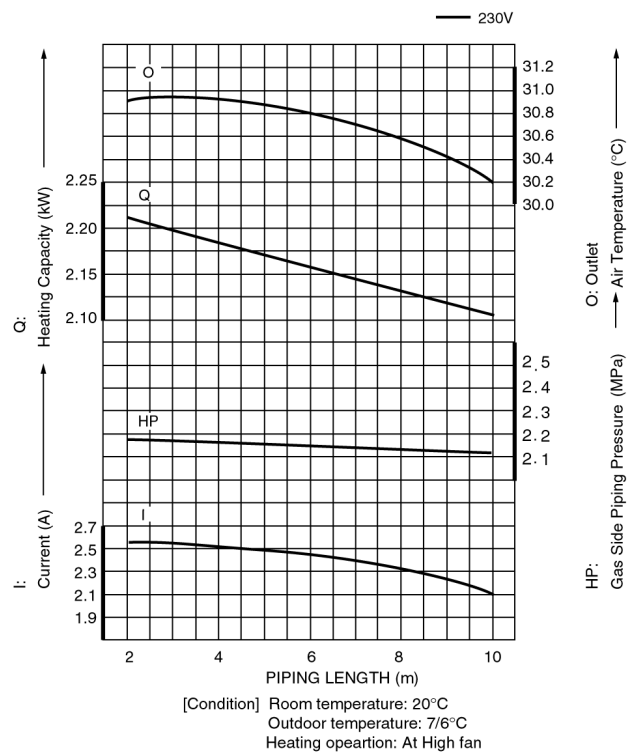

■ Operation characteristics

CS-W9CK / CU-W9CK

● Cooling Characteristic

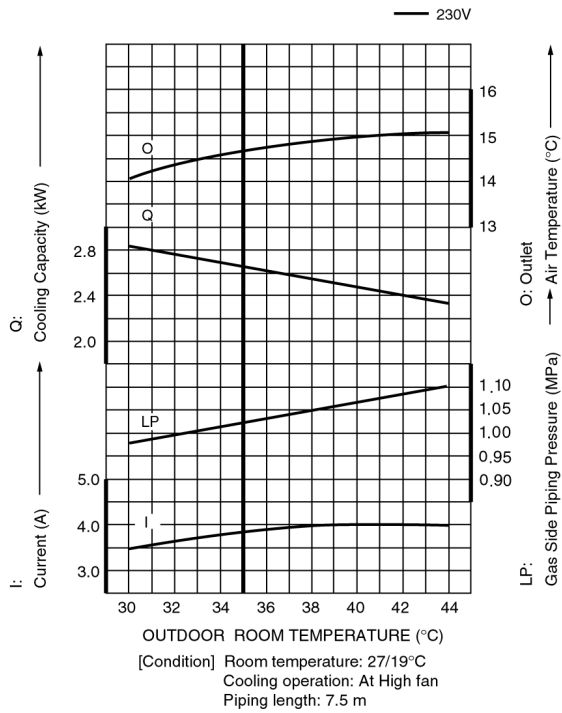

● Piping Length Characteristic (Cooling)

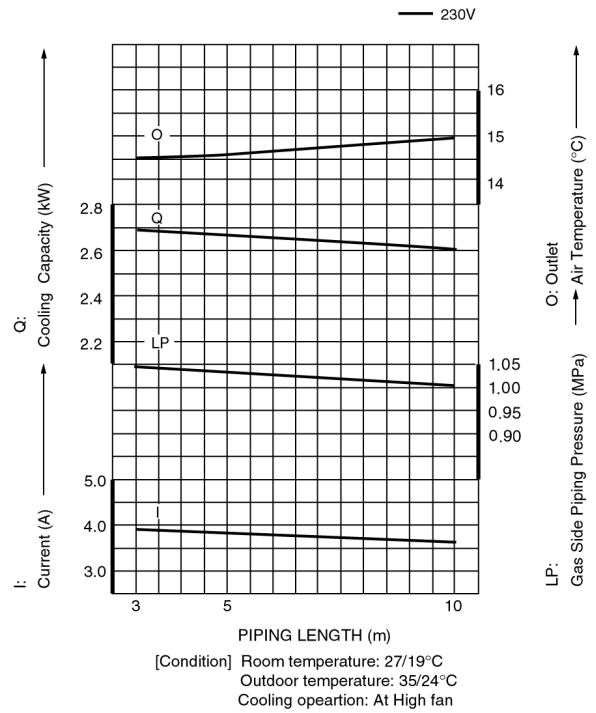

● Heating Characteristic

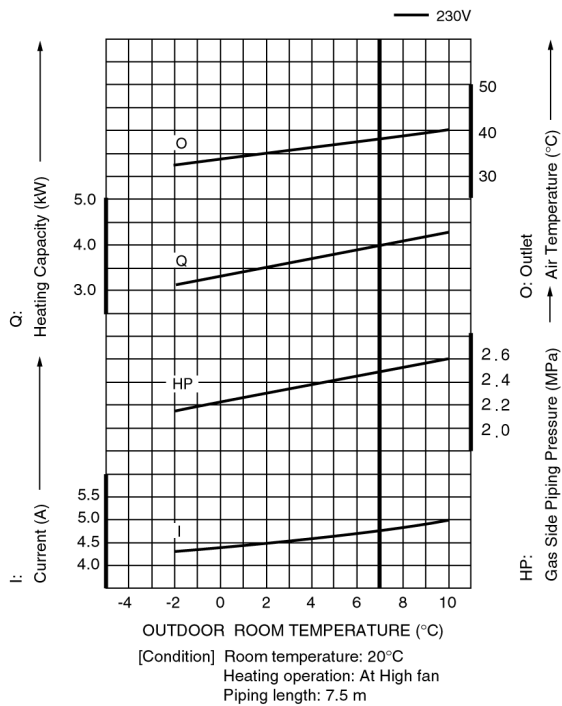

● Piping Length Characteristic (Heating)

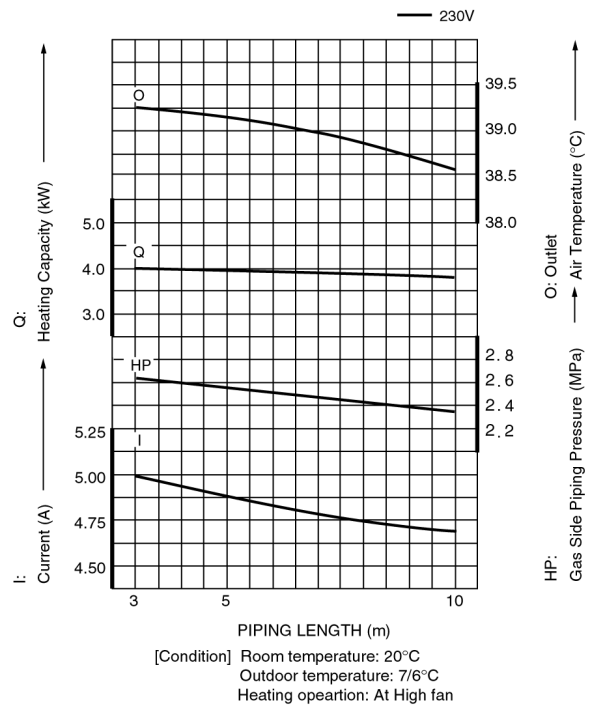

■ Operation characteristics

CS-W12CK / CU-W12CK

● Cooling Characteristic

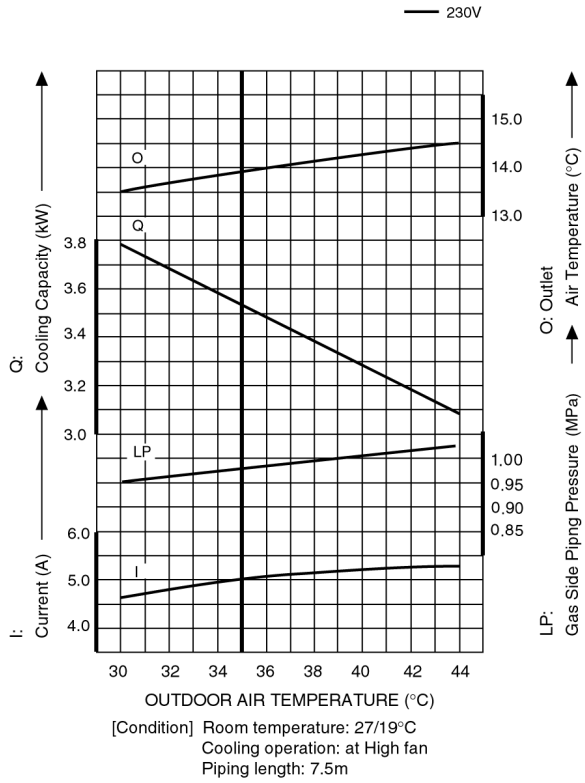

● Piping Length Characteristic (Cooling)

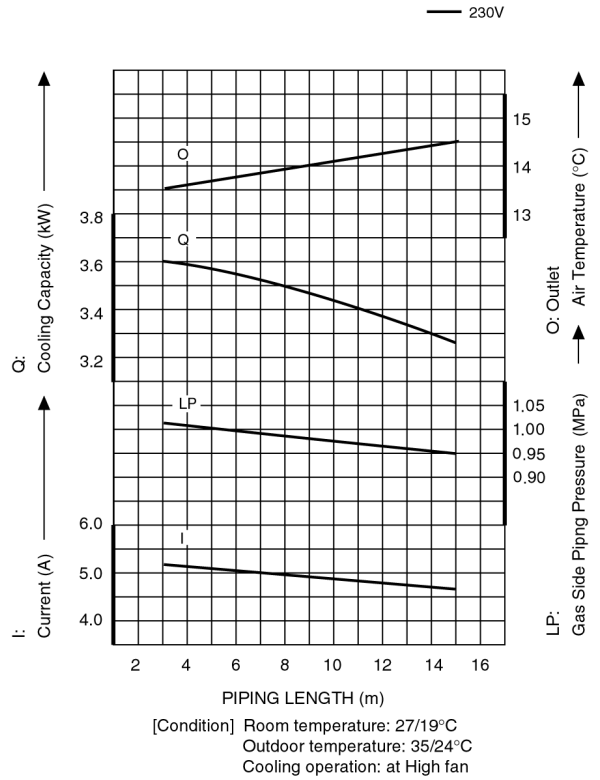

● Heating Characteristic

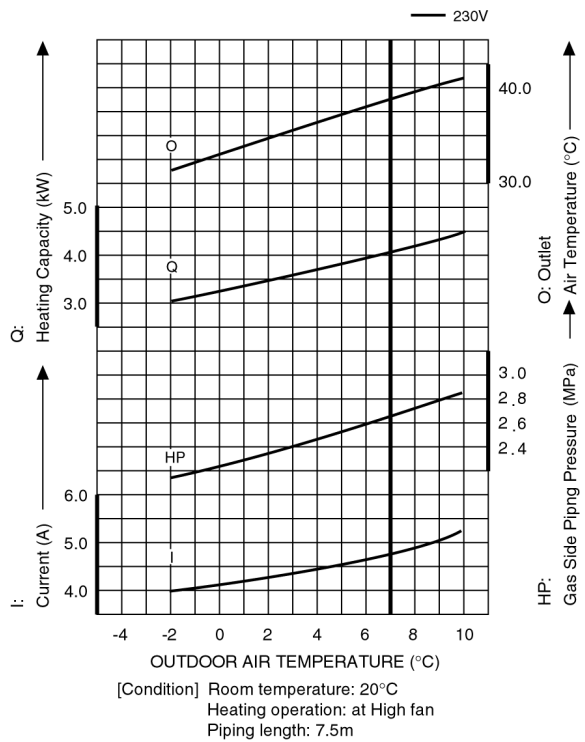

● Piping Length Characteristic (Heating)

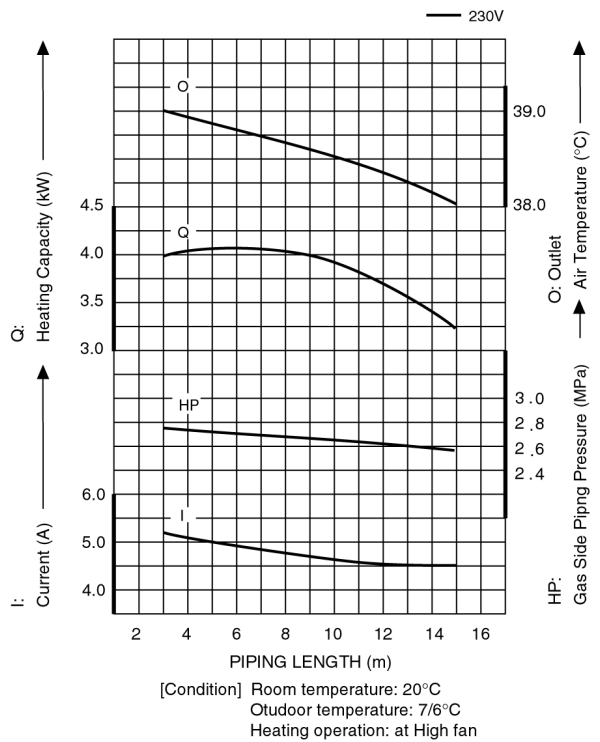

15 Exploded View

CS-W7CK / CS-W9CK / CS-W12CK

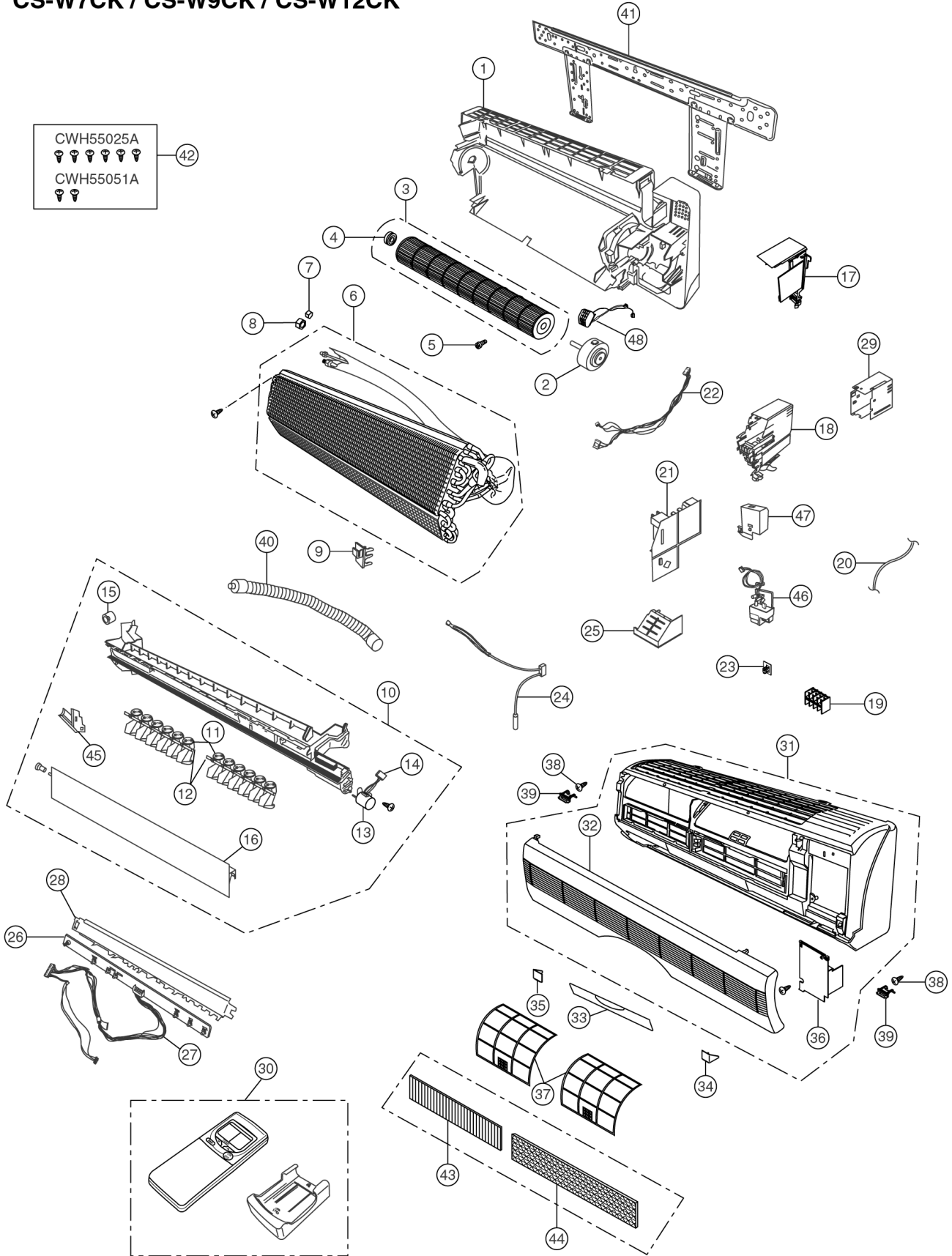

Note:
 The above exploded view is for the purpose of parts disassembly and replacement.
 The non-numbered parts are not kept as standard service parts.

16 Replacement Parts List

<Model: CS-W7CK / CS-W9CK / CS-W12CK>

REF. NO.	PART NAME & DESCRIPTION	QTY.	CS-W7CKP	CS-W9CKP	CS-W12CKP	REMARKS
1	CHASSY COMPLETE	1	CWD50C1246	←	←	
2	FAN MOTOR	1	CWA921060	←	←	0
3	CROSS FLOW FAN COMPLETE	1	CWH02C1012	←	←	
4	BEARING ASS'Y	1	CWH64K007	←	←	
5	SCREW - CROSS FLOW FAN	1	CWH4580304	←	←	
6	EVAPORATOR	1	CWB30C1262	CWB30C1271	CWB30C1251	
7	FLARE NUT	1	CWH6002140 (1/4")	←	←	
8	FLARE NUT	1	CWT25005 (3/8")	←	CWT25007 (1/2")	
9	INTAKE AIR SENSOR HOLDER	1	CWH32142	←	←	
10	DISCHARGE GRILLE COMPLETE	1	CWE20C2101	←	←	
11	VERTICAL VANE	12	CWE241068	←	←	
12	CONNECTING BAR	2	CWE261024	←	←	
13	AIR SWING MOTOR	1	CWA98259	←	←	0
14	LEAD WIRE - AIR SWING MOTOR	1	CWA67C3977	←	←	
15	CAP - DRAIN TRAY	1	CWH52C1001	←	←	
16	HORIZONTAL VANE	1	CWE241070	←	←	
17	PARTICULAR PIECE	1	CWD932162	←	←	
18	CONTROL BOARD	1	CWH102103	←	←	
19	TERMINAL BOARD COMPLETE	1	CWA28C2162	←	CWA28C2163	0
20	POWER SUPPLY CORD	1	CWA20C2159	←	←	
21	ELECTRONIC CONTROLLER - MAIN	1	CWA742881	CWA742880	CWA742873	0
22	LEAD WIRE - FAN MOTOR	1	CWA67C3729	←	←	
23	ELECTRONIC CONTROLLER - RECEIVER	1	CWA73C1124	←	←	0
24	SENSOR COMPLETE	1	CWA50C2122	←	←	0
25	CONTROL BOARD FRONT COVER	1	CWH131090	←	←	
26	ELECTRONIC CONTROLLER - INDICATOR	1	CWE39C1064	←	←	0
27	LEAD WIRE - INDICATOR	1	CWA67C3637	←	←	
28	INDICATOR HOLDER	1	CWD932163	←	←	
29	CONTROL BOARD TOP COVER	1	CWH131091	←	←	
30	REMOTE CONTROL COMPLETE	1	CWA75C2294	←	←	0
31	FRONT GRILLE COMPLETE	1	CWE11C2756	←	←	
32	INTAKE GRILLE	1	CWE22C1081	←	←	
33	CONTROL PANEL	1	CWE312274	←	←	
34	DECORATION BASE (R)	1	CWE351067	←	←	
35	DECORATION BASE (L)	1	CWE351068	←	←	
36	GRILLE DOOR	1	CWE141033	←	←	
37	AIR FILTER	2	CWD001047	←	←	
38	SCREW - FRONT GRILLE	2	XTN4+16C	←	←	
39	CAP - FRONT GRILLE	2	CWH521062	←	←	
40	DRAIN HOSE	1	CWH85285	←	←	
41	INSTALLATION PLATE	1	CWH36K1006	←	←	
42	BAG COMPLETE - INSTALLATION SCREW	1	CWH82C067	←	←	
43	AIR PURIFYING FILTER	1	CWMD00C0001	←	←	0
44	TRIPLE DEODORIZING FILTER	1	CWMD00C0004	←	←	0
45	FULCRUM	1	CWH621013	←	←	
46	ELECTRONIC CONTROLLER - IONIZER	1	CWA743099	←	←	
47	CASING - IONIZER	1	CWD932228	←	←	
48	ION GENERATOR	1	CWH94C0001	←	←	

(Note)

- All parts are supplied from MAICO, Malaysia (Vendor Code: 061).
- "O" marked parts are recommended to be kept in stock.

17 Exploded View

CU-W7CK / CU-W9CK / CU-W12CK

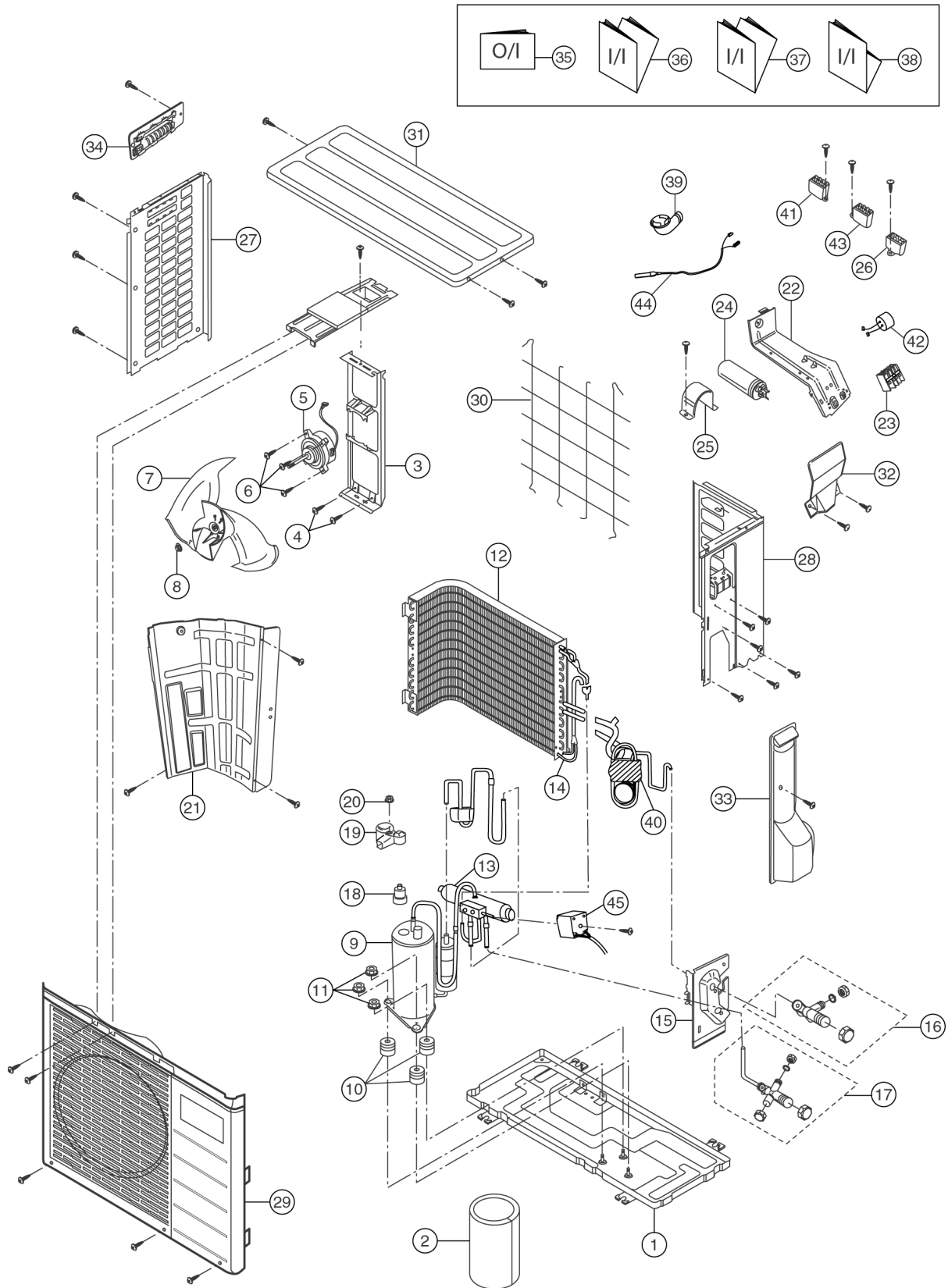

Note:

The above exploded view is for the purpose of parts disassembly and replacement.
 The non-numbered parts are not kept as standard service parts.

18 Replacement Parts List

<Model: CU-W7CK / CU-W9CK / CU-W12CK>

REF. NO.	PART NAME & DESCRIPTION	QTY.	CU-W7CKP5	CU-W9CKP5	CU-W12CKP5	REMARKS
1	CHASSY ASS'Y	1	CWD50K2073	←	CWD50K2074	
2	SOUND PROOF MATERIAL	1	CWG302088	←	←	
3	FAN MOTOR BRACKET	1	CWD541030	←	←	
4	SCREW - FAN MOTOR BRACKET	2	CWH55413	←	←	
5	FAN MOTOR	1	CWA951119	←	CWA951121	0
6	SCREW - FAN MOTOR MOUNT	3	CWH55406	←	←	
7	PROPELLER FAN ASS'Y	1	CWH03K1006	←	←	
8	NUT - PROPELLER FAN	1	CWH56053	←	←	
9	COMPRESSOR	1	GB080PAA	GB102PAA	GB134PAA	0
10	ANTI - VIBRATION BUSHING	3	CWH501024	←	←	
11	NUT - COMPRESSOR MOUNT	3	CWH56000	←	CWH4582065	
12	CONDENSER	1	CWB32C1116	←	CWB32C1108	
13	4-WAY VALVE	1	CWB001011	←	←	
14	STRAINER	1	CWB11025	←	←	
15	HOLDER COUPLING ASS'Y	1	CWH351023	←	←	
16	2-WAY VALVE (LIQUID)	1	CWB021057	←	←	0
17	3-WAY VALVE (GAS)	1	CWB011063	←	CWB011062	0
18	OVERLOAD PROTECTOR	1	CWA121058	CWA121059	CWA121057	0
19	TERMINAL COVER	1	CWH171021	←	←	
20	NUT - TERMINAL COVER	1	CWH561020	←	←	
21	SOUND PROOF BOARD	1	CWH151022	←	CWH151023	
22	CONTROL BOARD	1	CWH102102	←	←	
23	TERMINAL BOARD ASS'Y	1	CWA28K216	←	←	
24	CAPACITOR - COMPRESSOR	1	DS371256CPNA (25µF, 370VAC)	DS371306CPNA (30µF, 370VAC)	DS371356CPNA (35µF, 370VAC)	0
25	HOLDER CAPACITOR	1	CWH30057	←	←	
26	CAPACITOR - FAN MOTOR	1	CWA31618 (2.0µF, 450VAC)	←	←	0
27	CABINET SIDE PLATE (L)	1	CWE041031A	←	←	
28	CABINET SIDE PLATE (R)	1	CWE041032A	←	CWE041033A	
29	CABINET FRONT PLATE	1	CWE06K1034	←	←	
30	WIRE NET	1	CWD041021A	←	CWD041023A	
31	CABINET TOP PLATE	1	CWE031014A	←	←	
32	PLATE - C. B. COVER	1	CWH131088	←	←	
33	CONTROL BOARD COVER	1	CWH131092	←	←	
34	HANDLE	1	CWE161010	←	←	
35	OPERATION INSTRUCTIONS	1	CWF563838	←	←	
36	INSTALLATION INSTRUCTIONS (ENGLISH, FRANCAIS, ESPANOL & DEUTSCH)	1	CWF612304	←	←	
37	INSTALLATION INSTRUCTIONS (ITALIANO, NEDERLANDS, PORTUGUES & GREEK)	1	CWF612305	←	←	
38	INSTALLATION INSTRUCTIONS (RUSSIA)	1	CWF612306	←	←	
39	L-TUBE	1	CWH5850080	←	←	
40	TUBE ASS'Y (CHECK VALVE/CAPILLARY)	1	CWT01C2653	CWT01C2654	CWT01C2648	
41	ELECTRO MAGNETIC SWITCH	1	CWA00059	←	←	
42	ELECTROLYTIC CAPACITOR	1	CWA32C067	←	←	
43	ELECTRO MAGNETIC SWITCH	1	K6C2C7A00001	←	K6A2C7A00002	
44	TEMPERATURE RELAY	1	CWA14C1009	←	←	
45	V-COIL COMPLETE	1	CWA43C2069	←	←	

(Note)

- All parts are supplied from MAICO, Malaysia (Vendor Code: 061).
- "O" marked parts are recommended to be kept in stock.

19 Electronic Circuit Diagram

- CS-W7CK / CU-W7CK
- CS-W9CK / CU-W9CK
- CS-W12CK / CU-W12CK

SCHEMATIC DIAGRAM 1/3

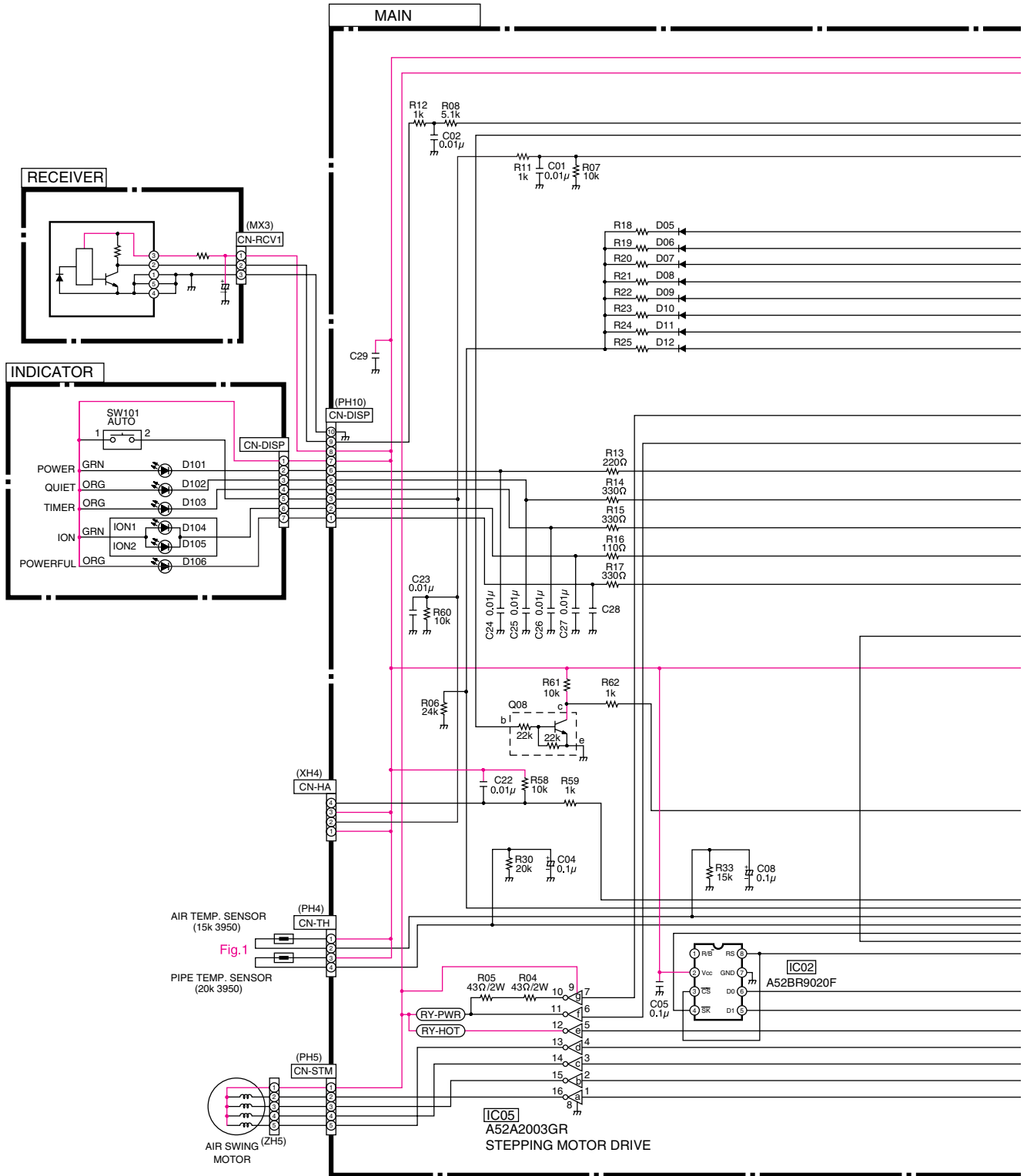

SCHEMATIC DIAGRAM 2/3

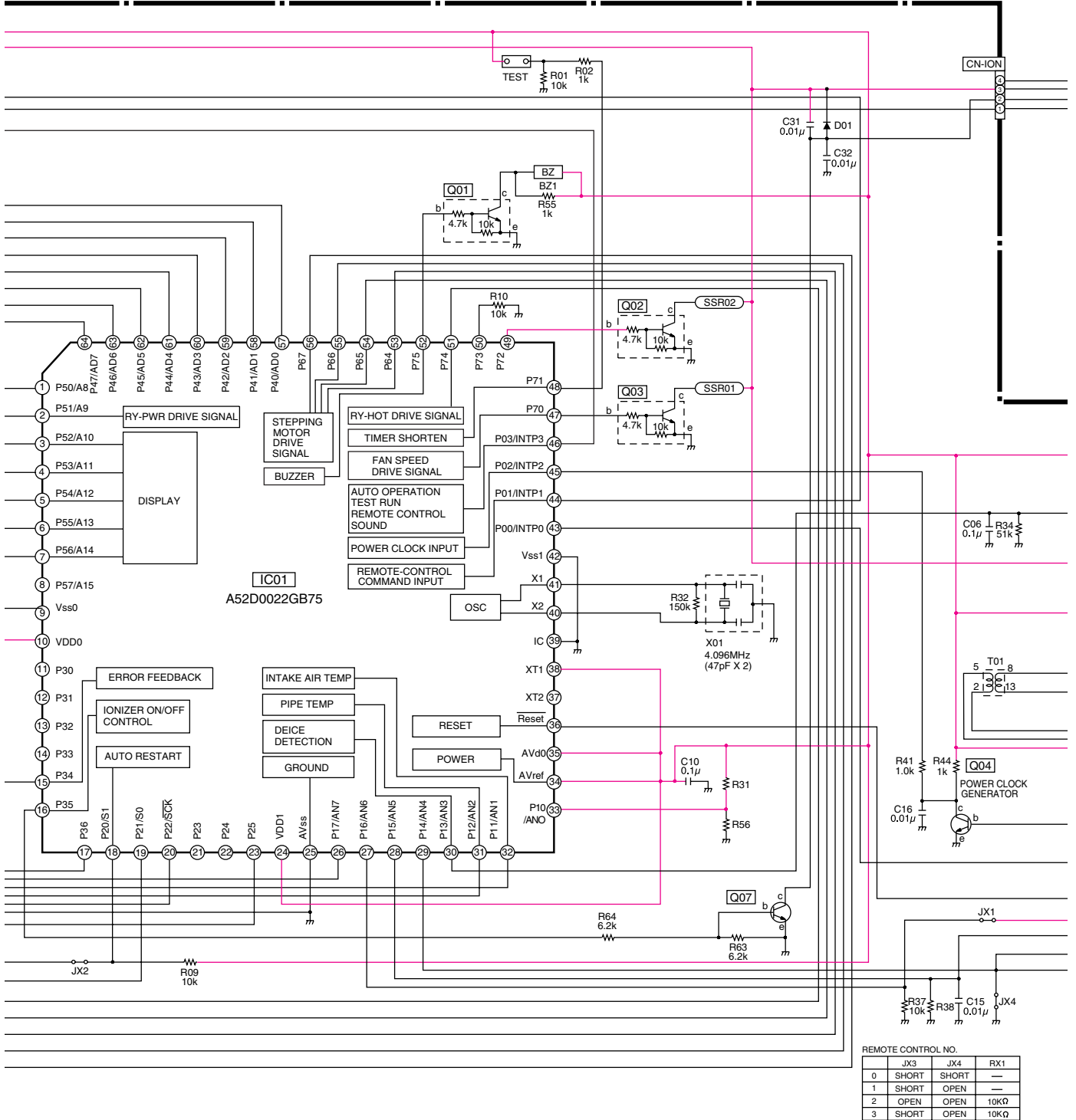

REMOTE CONTROL NO.

	JX3	JX4	RX1
0	SHORT	SHORT	—
1	SHORT	OPEN	—
2	OPEN	OPEN	10KΩ
3	SHORT	OPEN	10KΩ

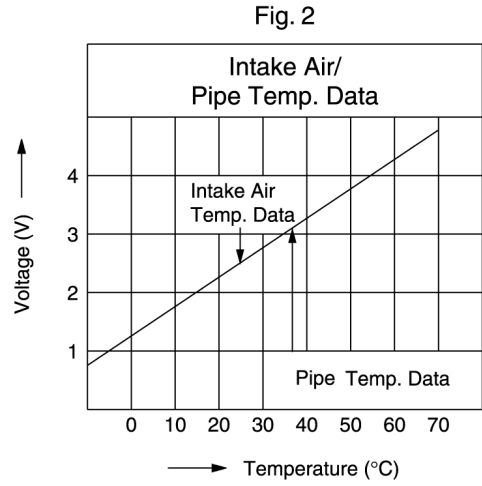
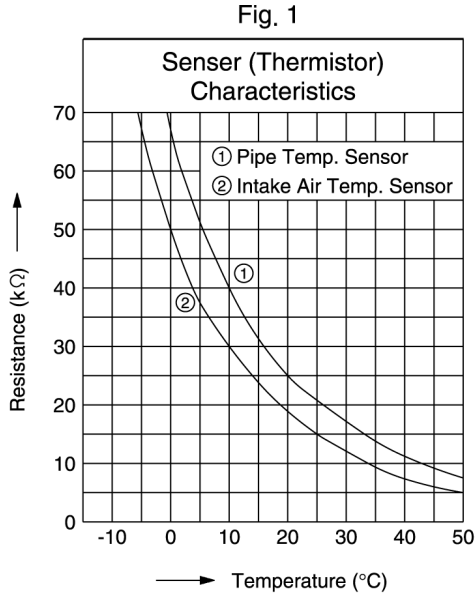
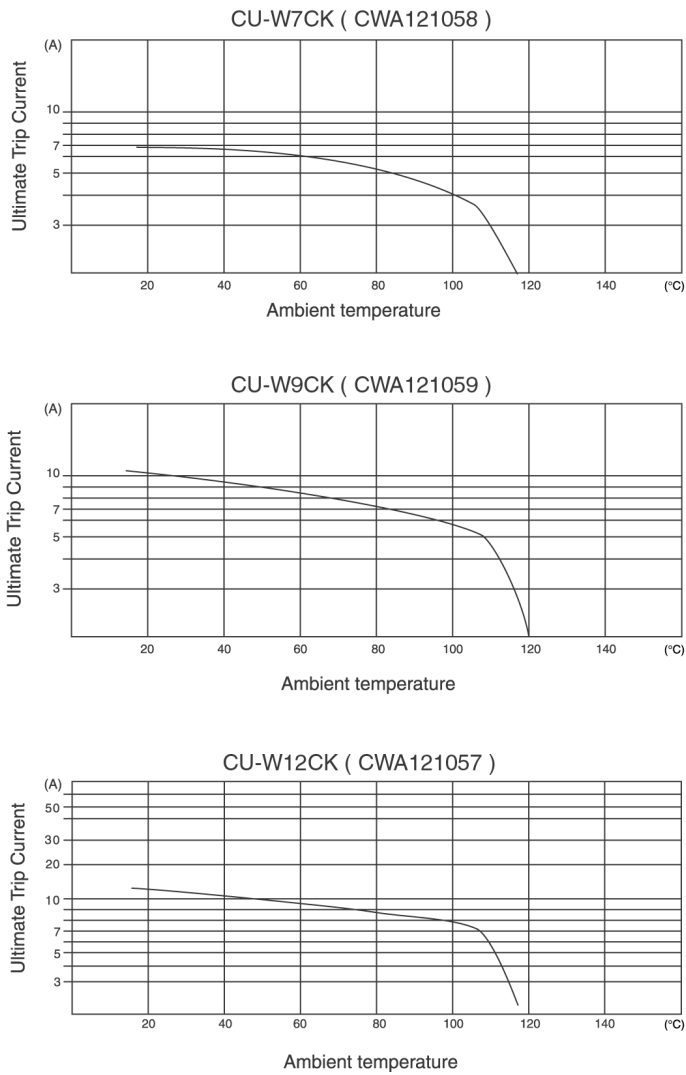

Fig. 3 OLP Characteristics (Compressor)



How to use electronic circuit diagram

Before using the circuit diagram, read the following carefully.

* Voltage measurement

Voltage has been measured with a digital tester when the indoor fan is set at high fan speed under the following conditions without setting the timer.

Use them for servicing.

Voltage indication is in Red at all operations.

	Intake air temperature	Temperature setting	Discharge air temperature	Pipe temperature
Cooling	27°C	16°C	17°C	15°C

* Indications for resistance

a. K....kΩ M....MΩ
W...watt Not indicated....1/4W

b. Type

Not indicated.....carbon resistor

Tolerance±5%



.....metal oxide resistor

Tolerance±1%

* Indications for capacitor

a. Unit μ....μF P....pF

b. Type Not indicated....ceramic capacitor

(S).....S series aluminium electrolytic capacitor

(Z).....Z series aluminium electrolytic capacitor

(SU).....SU series aluminium electrolytic capacitor

(P).....P series polyester system

(SXE).....SXE series aluminium electrolytic capacitor

(SRA).....SRA series aluminium electrolytic capacitor

(KME).....KME series aluminium electrolytic capacitor

* Diode without indication.....MA165

* Circuit Diagram is subject to change without notice for further development.

TIMER TABLE

Name	Time	Test Mode (When test point Short-circuited)	Remarks
Real Timer	1 hr.	1 min.	
	10 min.	10 sec.	
	1 min.	1 sec.	
Time Delay Safety Control	2 min. 58 sec.	0 sec.	
Forced Operation	60 sec.	0 sec.	
Time Save Control	7 min.	4.2 sec.	
Anti-Freezing	4 min.	0 sec.	
Auto Mode Judgement	25 sec.	0 sec.	
Soft Dry	OFF	6 min.	36 sec.
	ON	10 min.	60 sec.
Deodorizing Control	Cooling	40 sec.	4 sec.
		70 sec.	7 sec.
		20 sec.	2 sec.
		180 sec.	18 sec.
	Soft Dry	40 sec.	4 sec.
		360 sec.	36 sec.
Comp. Reverse Rotation Detection	5 min.	30 sec.	Comp. ON 5 min. and above
	2 min.	0 sec.	
Comp./ Fan Motor Delay Timer	1.6 sec.	0 sec.	
Powerful Mode Operation	15 min.	15 sec.	
Random Auto Restart Control	0 ~ 62 sec.	0 ~ 6.2 sec.	
TRS Recovery Detection	12 min.	72 sec.	
	6 min.	36 sec.	
	3 min.	18 sec.	
	1 min.	6 sec.	
Time Save Control (Heating)	30 min.	3 sec.	
4 Way Valve Control (Delay)	5 min.	30 sec.	
Deice Operation Occurs	60 min.	6 sec.	60 min. after previous deice
	4 min.	24 sec.	Continuously 4 min. Comp. ON
	50 sec.	0 sec.	TRS ON continuously for 50 sec. check
Overload Deice Timer	1 min.	6 sec.	Comp. ON continuously for 1 min. check
Deice End	12 min.	72 sec.	Max. Operation time
	30 sec.	3 sec.	30 sec. Comp. OFF after deice
	10 sec.	1 sec.	4-Way Valve ON 10 sec. later after deice
Deice Operation (Extend)	60 sec.	0 sec.	
	120 sec.	0 sec.	
	180 sec.	0 sec.	
Hotstart Finish	30 sec.	0 sec.	
Ion OFF Timer	10 min.	10 sec.	

19.1. REMOTE CONTROL

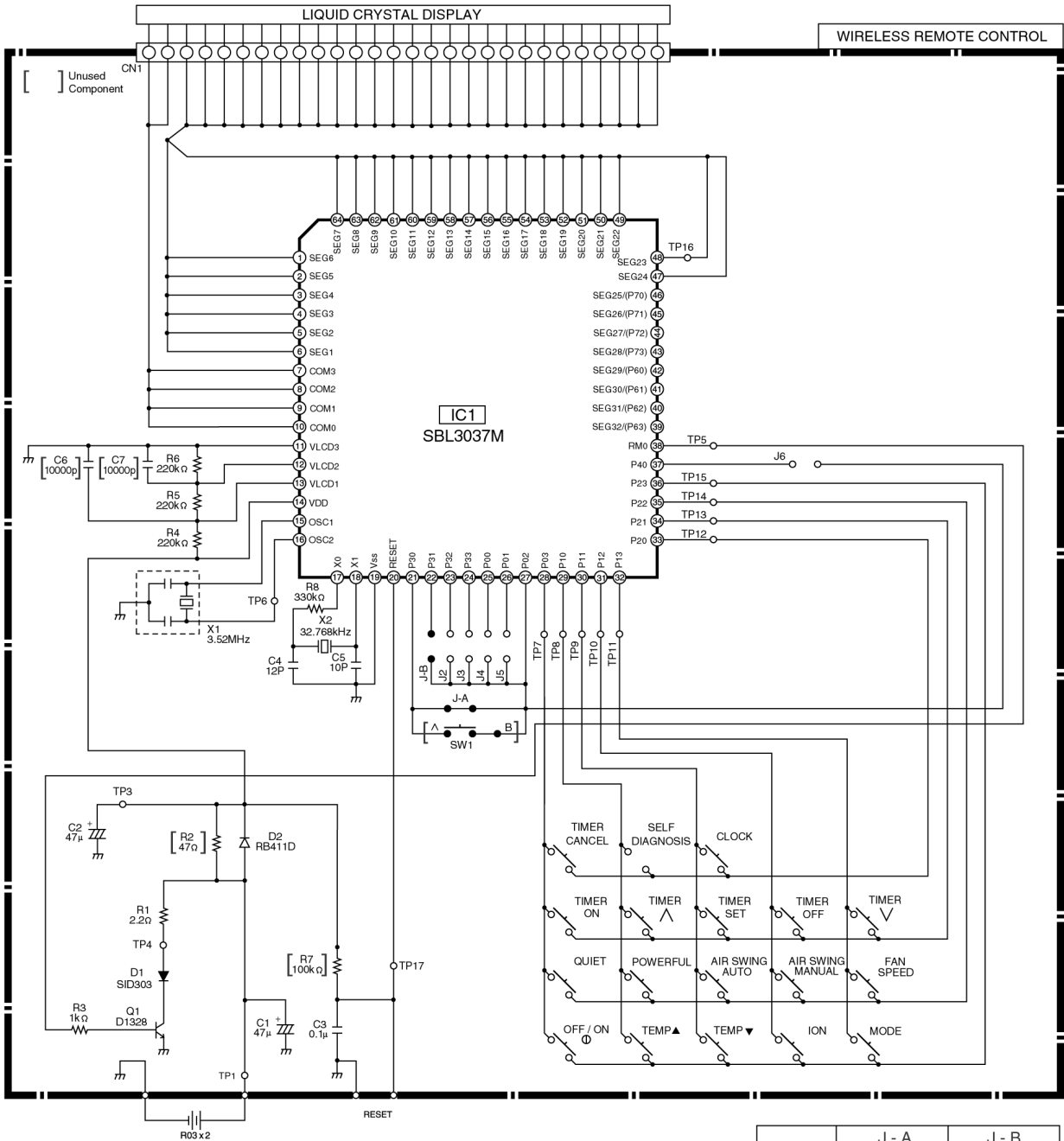

	J - A	J - B
0	SHORT	OPEN
1	OPEN	OPEN
2	SHORT	SHORT
3	OPEN	SHORT

19.2. PRINT PATTERN INDOOR UNIT PRINTED CIRCUIT BOARD

TOP VIEW

