

# INDOOR UNIT SERVICE MANUAL

No. OBH555

## Models

**MSZ-SF15VA** - E1

**MSZ-SF20VA** - E1

Outdoor unit service manual  
MXZ-B·VA Series (OBH554)  
MXZ-8A140A (OC316)

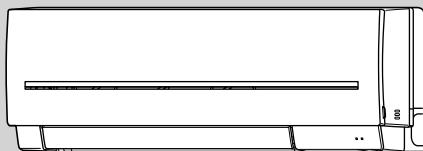

**MSZ-SF15VA** - E1  
**MSZ-SF20VA** - E1

## CONTENTS

1. TECHNICAL CHANGES .....	2
2. PART NAMES AND FUNCTIONS.....	3
3. SPECIFICATION.....	4
4. NOISE CRITERIA CURVES .....	5
5. OUTLINES AND DIMENSIONS .....	6
6. WIRING DIAGRAM.....	7
7. REFRIGERANT SYSTEM DIAGRAM .....	8
8. SERVICE FUNCTIONS .....	9
9. MICROPROCESSOR CONTROL .....	11
10. TROUBLESHOOTING.....	17
11. DISASSEMBLY INSTRUCTIONS.....	29

**PARTS CATALOG (OBB555)**

**NOTE:**  
RoHS compliant products have <G> mark on the spec name plate.



**MSZ-SF15VA - E1**

**MSZ-SF20VA - E1**

1. New model

## 2

# PART NAMES AND FUNCTIONS

MSZ-SF15VA MSZ-SF20VA

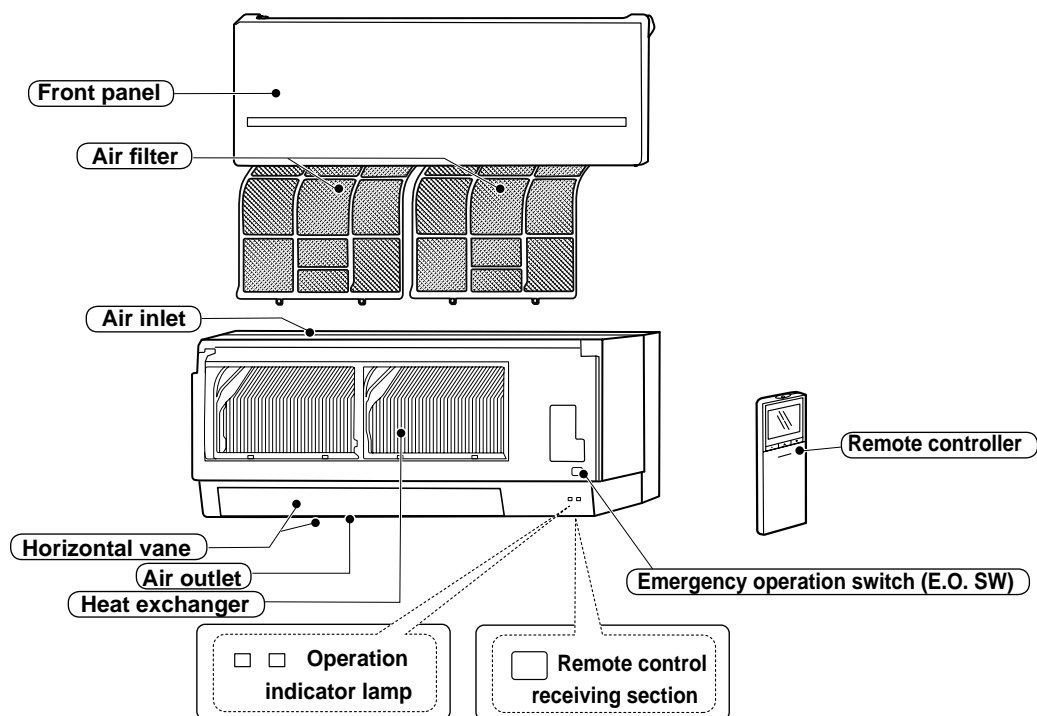

## ACCESSORIES

①	Installation plate	1
②	Installation plate fixing screw 4 × 25 mm	5
③	Remote controller holder	1
④	Fixing screw for ③ 3.5 × 16 mm (Black)	2
⑤	Battery (AAA) for remote controller	2
⑥	Wireless remote controller	1
⑦	Felt tape (Used for left or left-rear piping)	1

# 3

# SPECIFICATION

Indoor model				MSZ-SF15VA	MSZ-SF20VA	
Power supply				Single phase 230 V, 50 Hz		
Electrical data	Power input *1	Cooling	W	17	19	
		Heating		17	19	
	Running current *1	Cooling	A	0.17	0.19	
		Heating		0.17	0.19	
Fan motor	Model			RC0J40-FM		
	Current *1	Cooling	A	0.17	0.19	
		Heating		0.17	0.19	
Dimensions W × H × D			mm 760 × 250 × 168			
Weight			kg 7.7			
Special remarks	Air direction			5		
	Airflow	Cooling	Super High	m <sup>3</sup> /h	384	414
			High		330	
			Med.		276	
			Low		234	
			Silent		210	
		Heating	Super High	m <sup>3</sup> /h	408	438
			High		360	
			Med.		300	
			Low		264	
			Silent		222	
	Sound level	Cooling	Super High	dB(A)	40	42
			High		35	
			Med.		30	
			Low		26	
			Silent		21	
		Heating	Super High	dB(A)	40	42
			High		35	
			Med.		30	
			Low		26	
Silent			21			
Fan speed	Cooling	Super High	rpm	1,500	1,600	
		High		1,300		
		Med.		1,130		
		Low		980		
		Silent		900		
	Heating	Super High	rpm	1,500	1,600	
		High		1,350		
		Med.		1,160		
		Low		1,030		
		Silent		910		
Fan speed regulator			5			
Remote controller model			SG10D			

**NOTE:** Test conditions are based on ISO 5151.

Cooling: Indoor Dry-bulb temperature 27°C      Wet-bulb temperature 19°C

Outdoor Dry-bulb temperature 35°C

Heating: Indoor Dry-bulb temperature 20°C      Wet-bulb temperature 6°C

Outdoor Dry-bulb temperature 7°C

\*1 Measured under rated operating frequency.

\*2 For multi system.

### Specifications and rating conditions of main electric parts

Fuse	(F11)	T3.15AL250V
Horizontal vane motor	(MV)	12 VDC
Varistor	(NR11)	S10K300E2K1
Terminal block	(TB)	3P

# 4

# NOISE CRITERIA CURVES

## MSZ-SF15VA

FAN SPEED	FUNCTION	SPL(dB(A))	LINE
Super High	COOLING	40	●—●
	HEATING	40	○—○

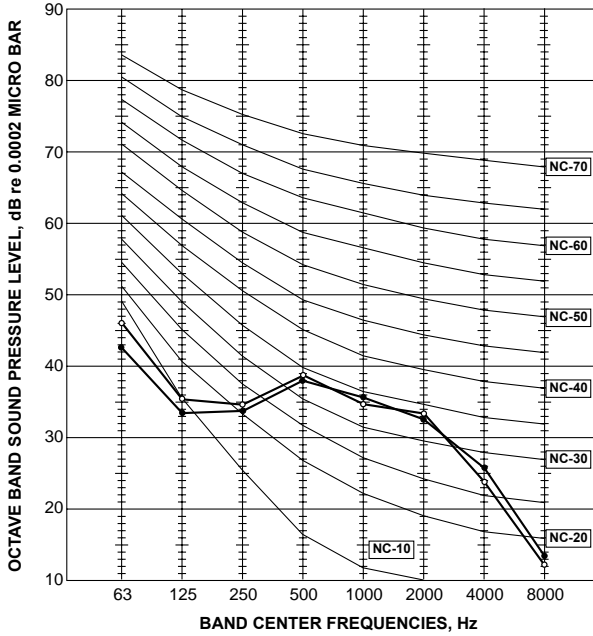

## MSZ-SF20VA

FAN SPEED	FUNCTION	SPL(dB(A))	LINE
Super High	COOLING	42	●—●
	HEATING	42	○—○

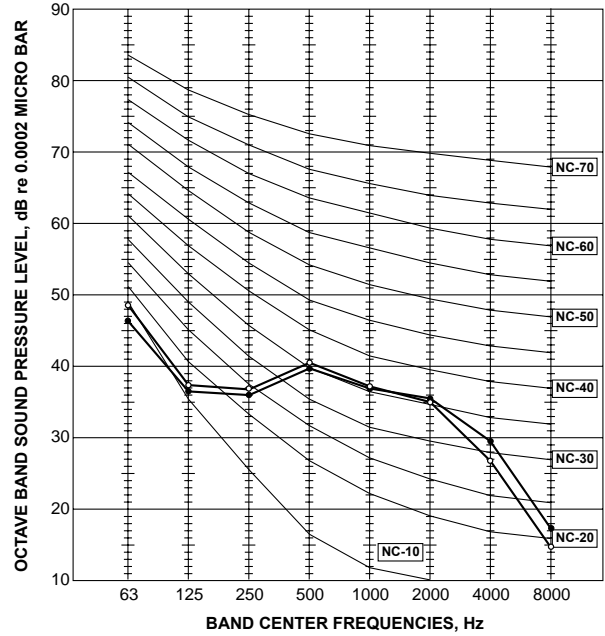

### Test conditions

Cooling: Dry-bulb temperature 27°C  
 Wet-bulb temperature 19°C  
 Heating: Dry-bulb temperature 20°C

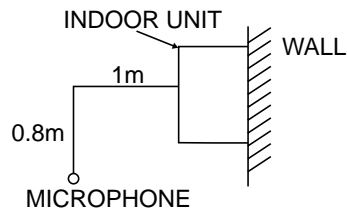

# 5

# OUTLINES AND DIMENSIONS

MSZ-SF15VA MSZ-SF20VA

Unit: mm

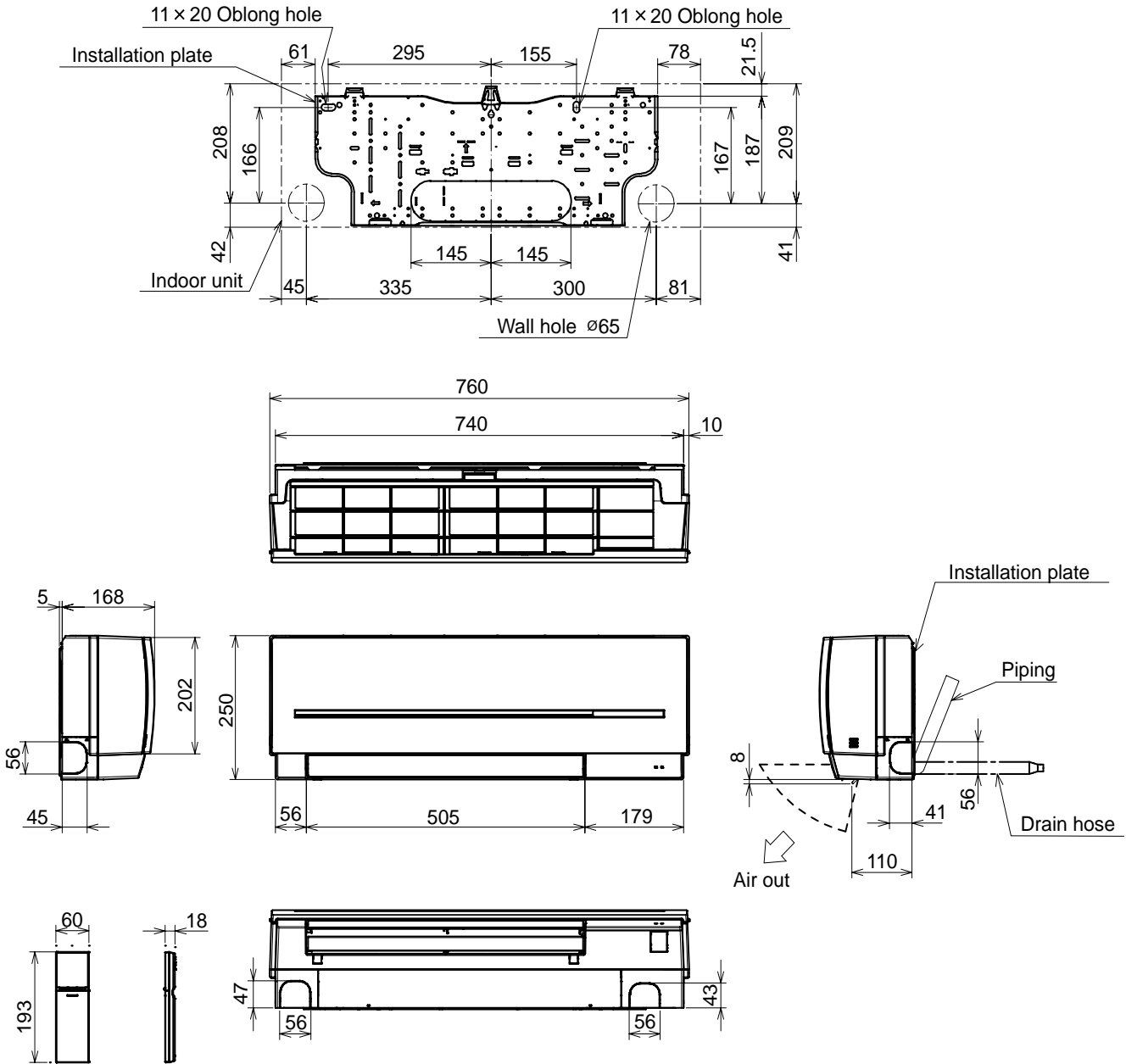

Piping	Insulation	ø35 O.D
	Liquid line	ø6.35-0.39m (Flared connection ø6.35)
	Gas line	ø9.52-0.34m (Flared connection ø9.52)
Drain hose	Insulation ø28	Connected part ø16 O.D

# 6

# WIRING DIAGRAM

## MSZ-SF15VA MSZ-SF20VA

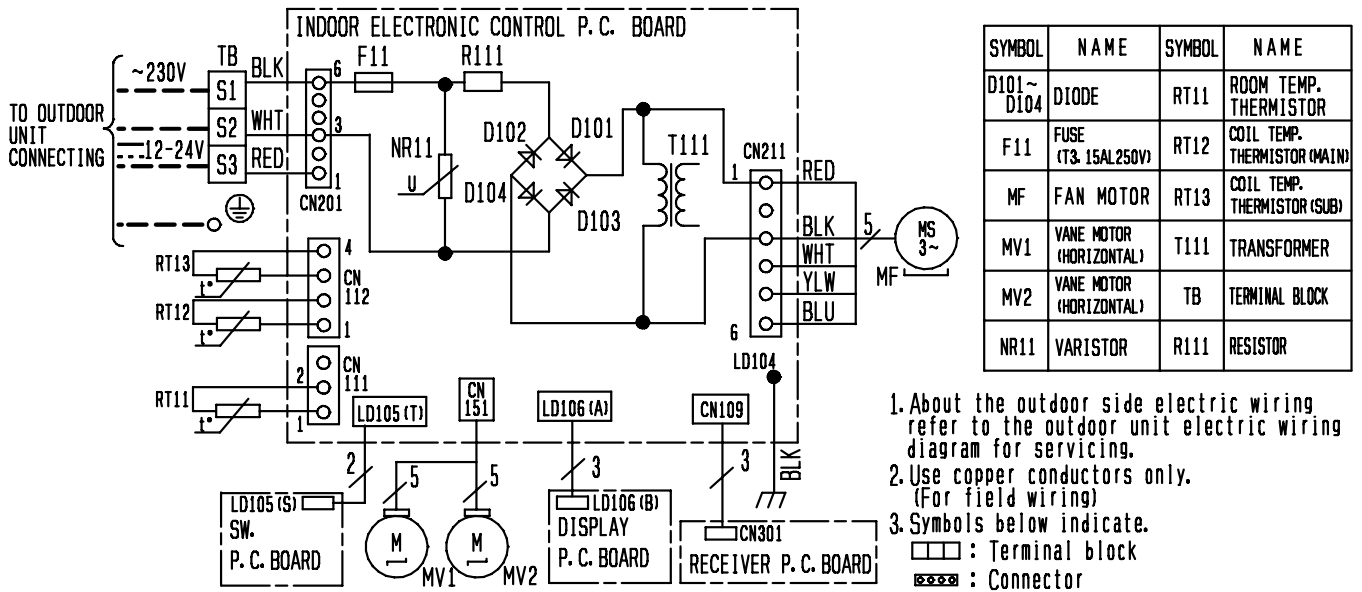

7

# REFRIGERANT SYSTEM DIAGRAM

MSZ-SF15VA MSZ-SF20VA

Unit: mm

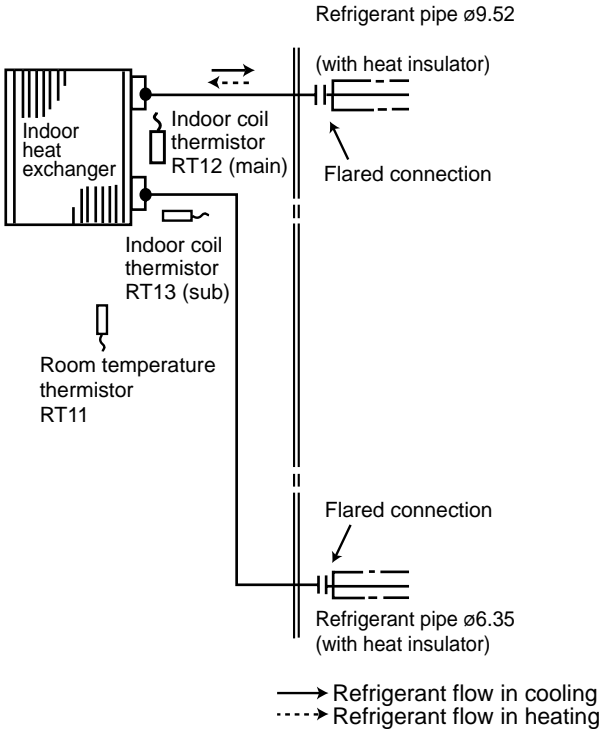



## MSZ-SF15VA MSZ-SF20VA

### 8-1. TIMER SHORT MODE

For service, set time can be shortened by short circuit of JPG and JPS on the electronic control P.C. board.  
The time will be shortened as follows. (Refer to 10-7.)

Set time: 1 minute → 1 second

Set time: 3 minutes → 3 seconds (It takes 3 minutes for the compressor to start operation. However, the starting time is shortened by short circuit-of JPG and JPS.)

### 8-2. P.C. BOARD MODIFICATION FOR INDIVIDUAL OPERATION

A maximum of 4 indoor units with wireless remote controllers can be used in a room.

In this case, to operate each indoor unit individually by each remote controller, P.C. boards of remote controller must be modified according to the number of the indoor unit.

#### How to modify the remote controller P.C. board

Remove batteries before modification.

The board has a print as shown below:

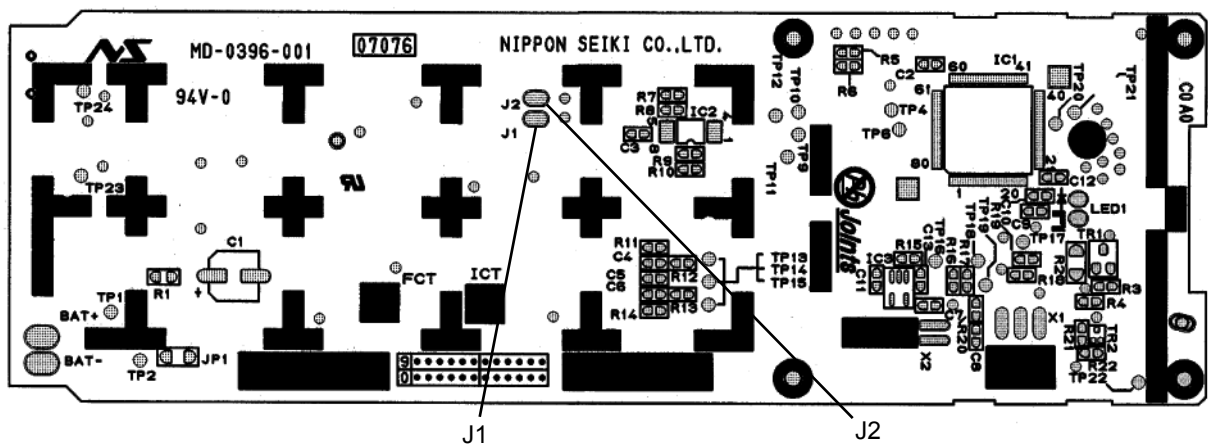

**NOTE:** For modification, take out the batteries and press the OPERATE/STOP (ON/OFF) button twice or 3 times at first.  
After modification, put back the batteries then press the RESET button.

The P.C. board has the print “J1” and “J2”. Solder “J1” and “J2” according to the number of indoor unit as shown in Table 1. After modification, press the RESET button.

**Table 1**

	1 unit operation	2 units operation	3 units operation	4 units operation
No. 1 unit	No modification	Same as at left	Same as at left	Same as at left
No. 2 unit	—	Solder J1	Same as at left	Same as at left
No. 3 unit	—	—	Solder J2	Same as at left
No. 4 unit	—	—	—	Solder both J1 and J2

#### How to set the remote controller exclusively for particular indoor unit

After you turn the breaker ON, the first remote controller that sends the signal to the indoor unit will be regarded as the remote controller for the indoor unit.

The indoor unit will only accept the signal from the remote controller that has been assigned to the indoor unit once they are set.

The setting will be cancelled if the breaker is turned OFF, or the power supply is shut down.

Please conduct the above setting once again after the power has restored.

### 8-3. AUTO RESTART FUNCTION

When the indoor unit is controlled with the remote controller, the operation mode, the set temperature, and the fan speed are memorized by the indoor electronic control P.C. board. "AUTO RESTART FUNCTION" automatically starts operation in the same mode just before the shutoff of the main power.

#### Operation

- ① If the main power has been cut, the operation settings remain.
- ② After the power is restored, the unit restarts automatically according to the memory.  
(However, it takes at least 3 minutes for the compressor to start running.)

#### How to release "AUTO RESTART FUNCTION"

- ① Turn off the main power for the unit.
- ② Solder the jumper wire to JR07 on the indoor electronic control P.C. board. (Refer to 10-7.)

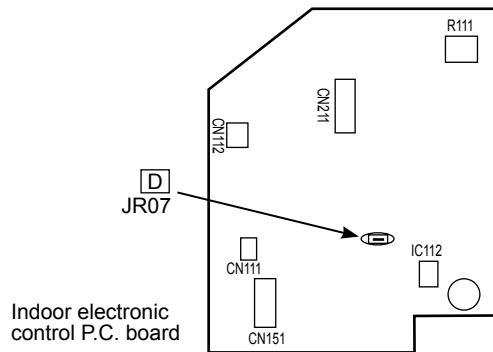

#### NOTE:

- The operation settings are memorized when 10 seconds have passed after the indoor unit was operated with the remote controller.
- If main power is turned OFF or a power failure occurs while AUTO START/STOP timer is active, the timer setting is cancelled.
- If the unit has been off with the remote controller before power failure, the auto restart function does not work as the power button of the remote controller is OFF.
- To prevent breaker OFF due to the rush of starting current, systematize other home appliance not to turn ON at the same time.
- When some air conditioners are connected to the same supply system, if they are operated before power failure, the starting current of all the compressors may flow simultaneously at restart.  
Therefore, the special counter-measures are required to prevent the main voltage-drop or the rush of the starting current by adding to the system that allows the units to start one by one.

## MSZ-SF15VA MSZ-SF20VA

## WIRELESS REMOTE CONTROLLER

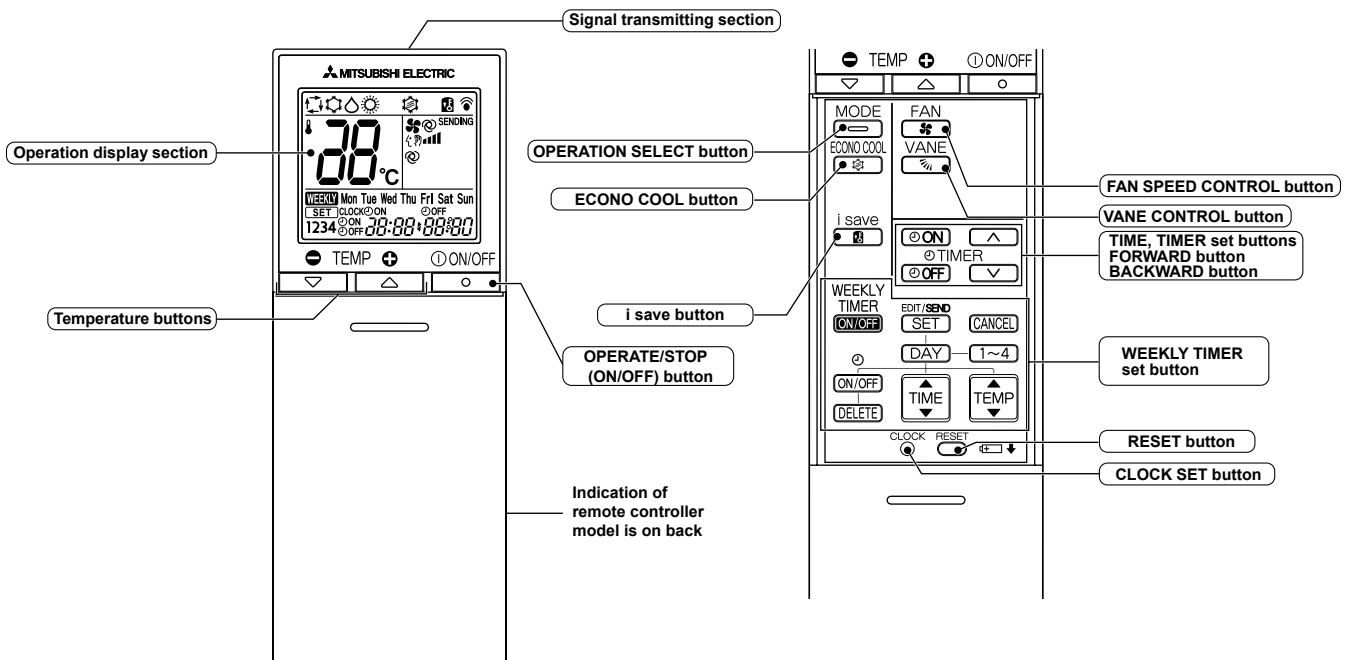

**NOTE:** Last setting will be stored after the unit is turned OFF with the remote controller. Indoor unit receives the signal of the remote controller with beeps.

## INDOOR UNIT DISPLAY SECTION

## Operation Indicator lamp

The operation indicator at the right side of the indoor unit indicates the operation state.

•The following indication applies regardless of shape of the indication.

Indication	Operation state	Room temperature
	The unit is operating to reach the set temperature	About 2°C or more away from set temperature
	The room temperature is approaching the set temperature	About 1 to 2°C from set temperature
	Standby mode (Only during multi system operation)	—

Lighted  
 Blinking  
 Not lighted

## 9-1. COOL (❄️) OPERATION

(1) Press OPERATE/STOP (ON/OFF) button.

OPERATION INDICATOR lamp of the indoor unit turns on with a beep tone.

(2) Select COOL mode with OPERATION SELECT button.

(3) Press TEMPERATURE buttons (TOO WARM or TOO COOL button) to select the desired temperature. The setting range is 16 - 31°C.

## 1. Coil frost prevention

The compressor operational frequency is controlled by the temperature of the indoor heat exchanger to prevent the coil from frosting.

When the temperature of indoor heat exchanger becomes too low, the coil frost prevention mode works.

The indoor fan operates at the set speed and the compressor stops. This mode continues until the temperature of indoor heat exchanger rises.

## 2. Low outside temperature operation

When the outside temperature is lower, low outside temperature operation starts, and the outdoor fan slows or stops.

## 9-2. DRY (△) OPERATION

- (1) Press OPERATE/STOP (ON/OFF) button.  
OPERATION INDICATOR lamp of the indoor unit turns on with a beep tone.
- (2) Select DRY mode with OPERATION SELECT button.
- (3) The set temperature is determined from the initial room temperature.

### 1. Coil frost prevention

Coil frost prevention is as same as COOL mode. (9-1.1.)

### 2. Low outside temperature operation

Low outside temperature operation is as same as COOL mode. (9-1.2.)

## 9-3. HEAT (⊙) OPERATION

- (1) Press OPERATE/STOP (ON/OFF) button.  
OPERATION INDICATOR lamp of the indoor unit turns on with a beep tone.
- (2) Select HEAT mode with OPERATION SELECT button.
- (3) Press TEMPERATURE buttons (TOO WARM or TOO COOL button) to select the desired temperature. The setting range is 16 - 31°C.

### 1. Cold air prevention control

When the compressor is not operating or is starting, and the temperature of indoor heat exchanger and/or the room temperature is low or when defrosting is being done, the indoor fan will stop or rotate in Very Low speed.

### 2. High pressure protection

The compressor operational frequency is controlled by the temperature of the indoor heat exchanger to prevent the condensing pressure from increasing excessively.

When the temperature of indoor heat exchanger becomes too high, the high pressure protection works.

The indoor fan operates following the cold air prevention control. This mode continues until the temperature of indoor heat exchanger falls.

### 3. Defrosting

Defrosting starts when the temperature of outdoor heat exchanger becomes too low.

The compressor stops once, the indoor/outdoor fans stop, the 4-way valve reverses, and the compressor re-starts.

This mode continues until the temperature of outdoor heat exchanger rises or the fixed time passes.

## 9-4. AUTO CHANGE OVER --- AUTO MODE OPERATION

Once desired temperature is set, unit operation is switched automatically between COOL and HEAT operation.

### Mode selection

#### (1) Initial mode

When unit starts the operation with AUTO operation from OFF:

- If the room temperature is higher than the set temperature, operation starts in COOL mode.
- If the room temperature is equal to or lower than the set temperature, operation starts in HEAT mode.

#### (2) Mode change

COOL mode changes to HEAT mode when about 15 minutes have passed with the room temperature 1°C below the set temperature.

HEAT mode changes to COOL mode when about 15 minutes have passed with the room temperature 1°C above the set temperature.

### NOTE 1

If two or more indoor units are operating in multi system, there might be a case that the indoor unit, which is operating in □ (AUTO), cannot change over to the other operating mode (COOL ↔ HEAT) and becomes a state of standby.

Refer to **NOTE 2 "FOR MULTI SYSTEM AIR CONDITIONER"**.

### NOTE 2

#### FOR MULTI SYSTEM AIR CONDITIONER OUTDOOR UNIT: MXZ series

Multi system air conditioner can connect two or more indoor units with one outdoor unit.

- When you try to operate two or more indoor units with one outdoor unit simultaneously, one for the cooling and the others for heating, the operation mode of the indoor unit that operates first is selected. Other indoor units cannot operate, and operation indicator lamp flashes as shown in the figure below. In this case, please set all the indoor units to the same operation mode.

#### OPERATION INDICATOR

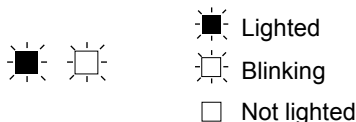

- When indoor unit starts the operation while the defrosting of outdoor unit is being done, it takes a few minutes (max. 10 minutes) to blow out the warm air.
- In the heating operation, though indoor unit that does not operate may get warm or the sound of refrigerant flowing may be heard, they are not malfunction. The reason is that the refrigerant continuously flows into it.

## 9-5. AUTO VANE OPERATION

### 1. Horizontal vane

#### (1) Vane motor drive

These models are equipped with a stepping motor for the horizontal vane. The rotating direction, speed, and angle of the motor are controlled by pulse signals (approximate 12 V) transmitted from indoor microprocessor.

(2) The horizontal vane angle and mode change as follows by pressing VANE CONTROL button.

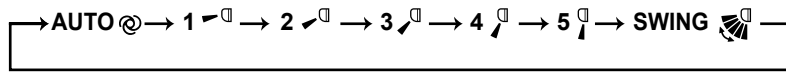

#### (3) Positioning

To confirm the standard position, the vane moves until it touches the vane stopper. Then the vane is set to the selected angle.

Confirming of standard position is performed in the following cases:

- When the operation starts or finishes (including timer operation).
- When the test run starts.
- When standby mode (only during multi system operation) starts or finishes.

#### (4) VANE AUTO (@) mode

In VANE AUTO mode, the microprocessor automatically determines the vane angle to make the optimum room temperature distribution.

In COOL and DRY operation

Vane angle is fixed to Horizontal position.

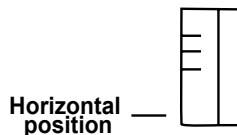

In HEAT operation

Vane angle is fixed to Angle 4.

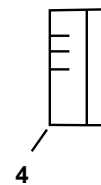

#### (5) STOP (operation OFF) and ON TIMER standby

In the following cases, the horizontal vane returns to the closed position.

- When OPERATE/STOP (ON/OFF) button is pressed (POWER OFF).
- When the operation is stopped by the emergency operation.
- When ON TIMER is ON standby.

#### (6) Dew prevention

During COOL or DRY operation with the vane angle at Angle 4 or 5 when the compressor cumulative operation time exceeds 1 hour, the vane angle automatically changes to Angle 1 for dew prevention.

#### (7) SWING (with a vane icon) mode

By selecting SWING mode with VANE CONTROL button, the horizontal vane swings vertically.

#### (8) Cold air prevention in HEAT operation

The horizontal vane position is set to Upward.

**NOTE:** When 2 or more indoor units are operated with multi outdoor unit, even if any indoor unit turns thermostat off, this control does not work in the indoor unit.

#### (9) ECONO COOL (with a vane icon) operation (ECONOMical operation)

When ECONO COOL button is pressed in COOL mode, set temperature is automatically set 2°C higher.

Also the horizontal vane swings in various cycle.

SWING operation makes you feel cooler than set temperature. So, even though the set temperature is higher, the air conditioner can keep comfort. As a result, energy can be saved.

To cancel this operation, select a different mode or press one of the following buttons in ECONO COOL operation: ECONO COOL, VANE CONTROL button.

## 9-6. TIMER OPERATION

### 1. How to set the time

(1) Check that the current time is set correctly.

**NOTE:** Timer operation will not work without setting the current time. Initially "0:00" blinks at the current time display of TIME MONITOR, so set the current time correctly with CLOCK SET button.

#### How to set the current time

(a) Press the CLOCK set button.

(b) Press the TIME SET buttons ( $\square\wedge$  and  $\square\vee$ ) to set the current time.

- Each time FORWARD button ( $\square\wedge$ ) is pressed, the set time increases by 1 minute, and each time BACKWARD button ( $\square\vee$ ) is pressed, the set time decreases by 1 minute.

- Pressing those buttons longer, the set time increases/decreases by 10 minutes.

(c) Press the CLOCK set button.

(2) Press OPERATE/STOP (ON/OFF) button to start the air conditioner.

(3) Set the time of timer.

#### ON timer setting

(a) Press ON TIMER button ( $\text{ON}$ ) during operation.

(b) Set the time of the timer using TIME SET buttons ( $\square\wedge$  and  $\square\vee$ ).\*

#### OFF timer setting

(a) Press OFF TIMER button ( $\text{OFF}$ ) during operation.

(b) Set the time of the timer using TIME SET buttons ( $\square\wedge$  and  $\square\vee$ ).\*

\* Each time FORWARD button ( $\square\wedge$ ) is pressed, the set time increases by 10 minutes: each time BACKWARD button ( $\square\vee$ ) is pressed, the set time decreases by 10 minutes.

### 2. To release the timer

To release ON timer, press ON TIMER button ( $\text{ON}$ ).

To release OFF timer, press OFF TIMER button ( $\text{OFF}$ ).

TIMER is cancelled and the display of set time disappears.

## PROGRAM TIMER

- OFF timer and ON timer can be used in combination. The timer of the set time that is reached first will operate first.
- "◀" and "▶" display shows the order of OFF timer and ON timer operation.

(Example 1) The current time is 8:00 PM.

The unit turns off at 11:00 PM, and on at 6:00 AM.

(Example 2) The current time is 11:00 AM.

The unit turns on at 5:00 PM, and off at 9:00 PM.

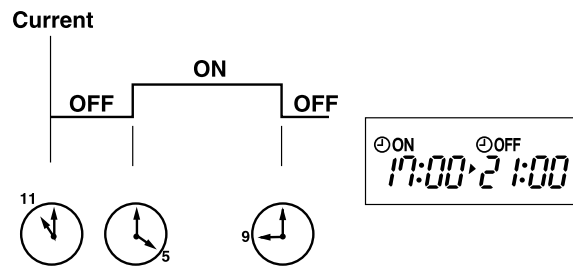
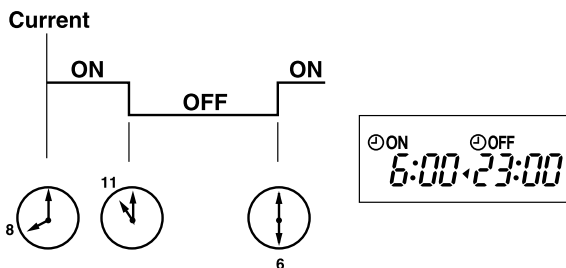

**NOTE:** If the main power is turned OFF or a power failure occurs while ON/OFF timer is active, the timer setting is cancelled. As these models are equipped with an auto restart function, the air conditioner starts operating with timer cancelled when power is restored.

## 9-7. WEEKLY TIMER OPERATION

- A maximum of 4 ON or OFF timers can be set for individual days of the week.
- A maximum of 28 ON or OFF timers can be set for a week.

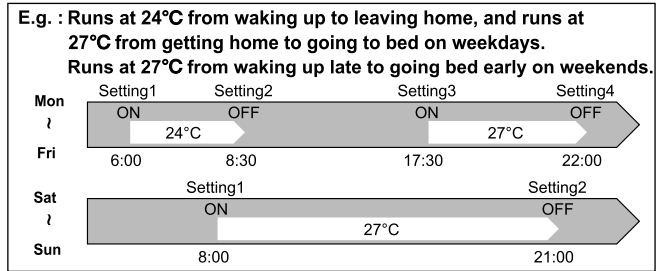

### NOTE:

The simple ON/OFF timer setting is available while the weekly timer is on. In this case, the ON/OFF timer has priority over the weekly timer; the weekly timer operation will start again after the simple ON/OFF timer is complete.

### 1. How to set the weekly timer

\* Make sure that the current time and day are set correctly.

- (1) Press **EDIT/SEND SET** button to enter the weekly timer setting mode.

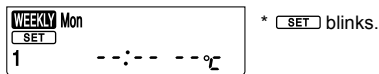

- (2) Press **DAY** and **1~4** buttons to select setting day and number.

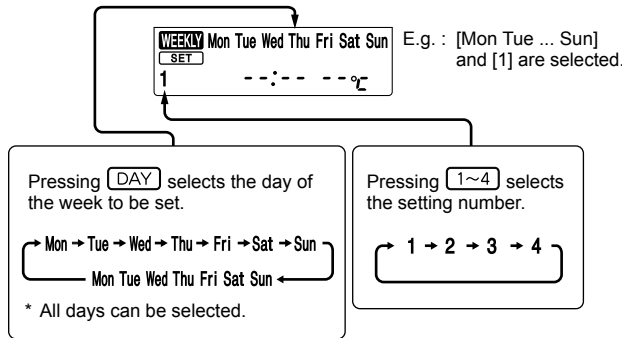

- (3) Press **ON/OFF**, **TIME**, and **TEMP** buttons to set ON/OFF, time, and temperature.

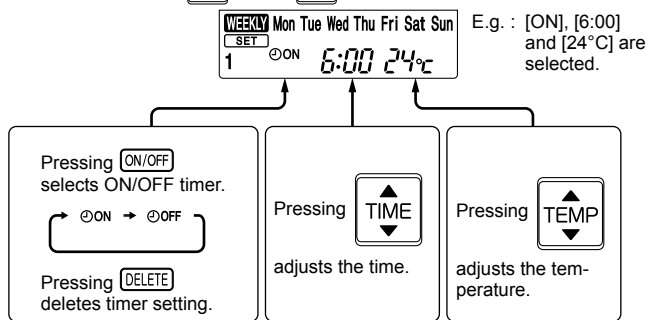

\* Hold down the button to change the time quickly.



Press **DAY** and **1~4** buttons to continue setting the timer for other days and/or numbers.

- (4) Press **EDIT/SEND SET** button to complete and transmit the weekly timer setting.





### NOTE:

- Press **EDIT/SEND SET** button to transmit the setting information of weekly timer to the indoor unit. Point the remote controller toward the indoor unit for 3 seconds.
- When setting the timer for more than one day of the week or one number, **EDIT/SEND SET** button does not have to be pressed per each setting. Press **EDIT/SEND SET** button once after all the settings are complete. All the weekly timer settings will be saved.
- Press **EDIT/SEND SET** button to enter the weekly timer setting mode, and press and hold **DELETE** button for 5 seconds to erase all weekly timer settings. Point the remote controller toward the indoor unit.

(5) Press  button to turn the weekly timer ON. (  lights.)

•When the weekly timer is ON, the day of the week whose timer setting is complete, will light.

Press  button again to turn the weekly timer OFF. (  goes out.)



**NOTE:**

The saved settings will not be cleared when the weekly timer is turned OFF.

**2. Checking weekly timer setting**

(1) Press  button to enter the weekly timer setting mode.

\* blinks.

(2) Press  or  buttons to view the setting of the particular day or number.

(3) Press  button to exit the weekly timer setting.

**NOTE:**

When all days of the week are selected to view the settings and a different setting is included among them,  will be displayed.

**9-8. i-save (i) OPERATION**

**1. How to set i-save operation**

- (1) Press OPERATE/STOP (ON/OFF) button.
- (2) Select COOL, HEAT or ECONO COOL mode.
- (3) Press i-save button.
- (4) Set the temperature, fan speed, and airflow direction for i-save operation.

**NOTE:**

- i-save operation cannot be selected during DRY or AUTO mode operation.
- The setting range of HEAT mode i-save operation is 10°C and 16 - 31°C.
- 2 groups of setting can be saved. (One for COOL/ECONO COOL, one for HEAT)

**2. How to cancel operation**

- Press i-save button again.
  - i-save operation can also be cancelled by pressing OPERATION SELECT button to change the operation mode.
- The same setting is select from the next time by simply pressing i-save button.

**9-9. EMERGENCY/TEST OPERATION**

In case of test run operation or emergency operation, use EMERGENCY OPERATION switch on the right side of the indoor unit. Emergency operation is available when the remote controller is missing, has failed or the batteries of the remote controller run down. The unit will start and OPERATION INDICATOR lamp will light. The first 30 minutes of operation is the test run operation. This operation is for servicing. The indoor fan runs at High speed and the system is in continuous operation (The thermostat does not work). After 30 minutes of test run operation, the system shifts to EMERGENCY COOL/HEAT MODE with a set temperature of 24°C. The fan speed shifts to Med. In the test run or emergency operation, the horizontal vane operates in VANE AUTO (Ⓜ) mode. Emergency operation continues until EMERGENCY OPERATION switch is pressed once or twice or the unit receives any signal from the remote controller. In case of latter, normal operation will start.

**NOTE:** Do not press EMERGENCY OPERATION switch during normal operation.

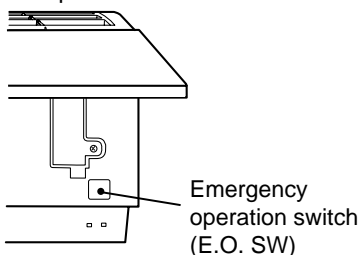

Operation mode	COOL/HEAT
Set temperature	24°C
Fan speed	Med.
Horizontal vane	Auto

The operation mode is indicated by the Operation Indicator lamp as following

**Operation Indicator lamp**

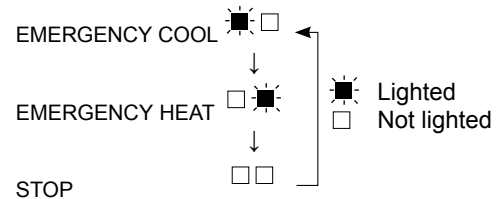

**9-10. 3-MINUTE TIME DELAY OPERATION**

When the system turns OFF, compressor will not restart for 3 minutes as 3-minute time delay function operates to protect compressor from overload.



## MSZ-SF15VA MSZ-SF20VA

## 10-1. CAUTIONS ON TROUBLESHOOTING

## 1. Before troubleshooting, check the following

- 1) Check the power supply voltage.
- 2) Check the indoor/outdoor connecting wire for miswiring.

## 2. Take care of the following during servicing

- 1) Before servicing the air conditioner, be sure to turn OFF the main unit first with the remote controller, and then after confirming the horizontal vane is closed, turn OFF the breaker and/or disconnect the power plug.
- 2) Be sure to turn OFF the power supply before removing the front panel, the cabinet, the top panel, and the P.C. board.
- 3) When removing the P.C. board, hold the edge of the board with care NOT to apply stress on the components.
- 4) When connecting or disconnecting the connectors, hold the housing of the connector. DO NOT pull the lead wires.

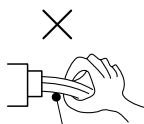

Lead wiring

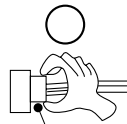

Housing point

## 3. Troubleshooting procedure

- 1) First, check if the OPERATION INDICATOR lamp on the indoor unit is flashing ON and OFF to indicate an abnormality.  
To make sure, check how many times the abnormality indication is flashing ON and OFF before starting service work.
- 2) Before servicing, check that the connector and terminal are connected properly.
- 3) If the P.C. board is supposed to be defective, check the copper foil pattern for disconnection and the components for bursting and discoloration.
- 4) When troubleshooting, refer to 10-2., 10-3. and 10-4.

## 4. How to replace batteries

Weak batteries may cause the remote controller malfunction.

In this case, replace the batteries to operate the remote controller normally.

- ① Remove the front lid and insert batteries.  
Then reattach the front lid.

- ② Press RESET button with a thin instrument, and then use the remote controller.

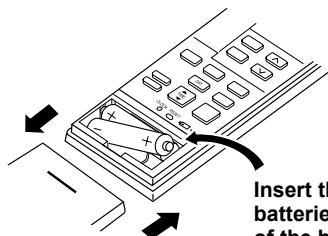

Insert the negative pole of the batteries first. Check if the polarity of the batteries is correct.

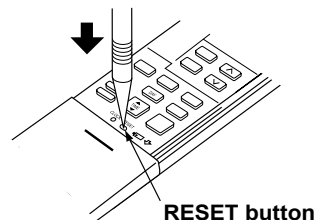

RESET button

**NOTE:** 1. If RESET button is not pressed, the remote controller may not operate correctly.

2. This remote controller has a circuit to automatically reset the microcomputer when batteries are replaced.

This function is equipped to prevent the microcomputer from malfunctioning due to the voltage drop caused by the battery replacement.

## 10-2. FAILURE MODE RECALL FUNCTION

### Outline of the function

This air conditioner can memorize the abnormal condition which has occurred once.

Even though LED indication listed on the troubleshooting check table (10-4.) disappears, the memorized failure details can be recalled.

### 1. Flow chart of failure mode recall function for the indoor/outdoor unit

#### Operational procedure

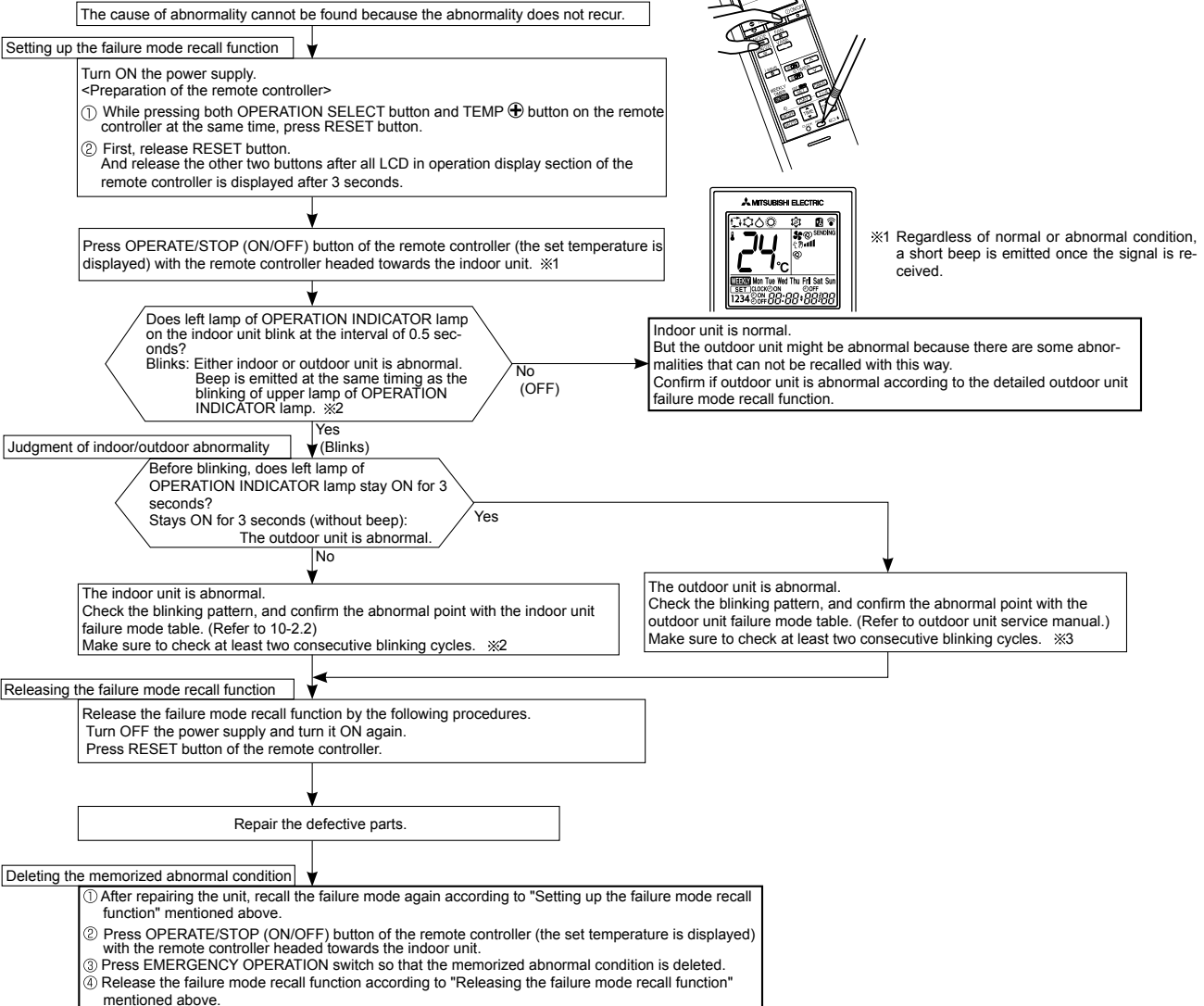

- NOTE:** 1. Make sure to release the failure mode recall function once it is set up, otherwise the unit cannot operate properly.  
 2. If the abnormal condition is not deleted from the memory, the last abnormal condition is kept memorized.

※2. Blinking pattern when the indoor unit is abnormal:

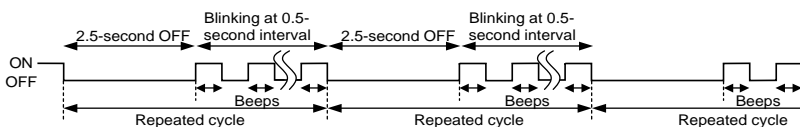

※3. Blinking pattern when the outdoor unit is abnormal:

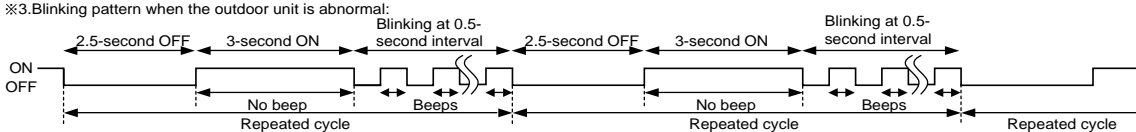



**2. Indoor unit failure mode table**

Upper lamp of OPERATION INDICATOR lamp	Abnormal point (Failure mode)	Condition	Correspondence
Not lighted	Normal	—	—
1-time flash every 0.5-second	Room temperature thermistor	The room temperature thermistor short or open circuit is detected every 8 seconds during operation.	Refer to the characteristics of the room temperature thermistor (10-7.).
2-time flash 2.5-second OFF	Indoor coil thermistor	The indoor coil thermistor short or open circuit is detected every 8 seconds during operation.	Refer to the characteristics of the main indoor coil thermistor, the sub indoor coil thermistor (10-7.).
3-time flash 2.5-second OFF	Serial signal	The serial signal from outdoor unit is not received for a maximum of 6 minutes.	Refer to 10-6.Ⓒ "How to check miswiring and serial signal error".
11-time flash 2.5-second OFF	Indoor fan motor	The rotational frequency feedback signal is not emitted during the 12 seconds the indoor fan operation.	Refer to 10-6.Ⓐ "Check of indoor fan motor".
12-time flash 2.5-second OFF	Indoor control system	It cannot properly read data in the nonvolatile memory of the indoor electronic control P.C. board.	Replace the indoor electronic control P.C. board.

**NOTE:** Blinking patterns of this mode differ from the ones of TROUBLESHOOTING CHECK TABLE (10-4.).

### 10-3. INSTRUCTION OF TROUBLESHOOTING

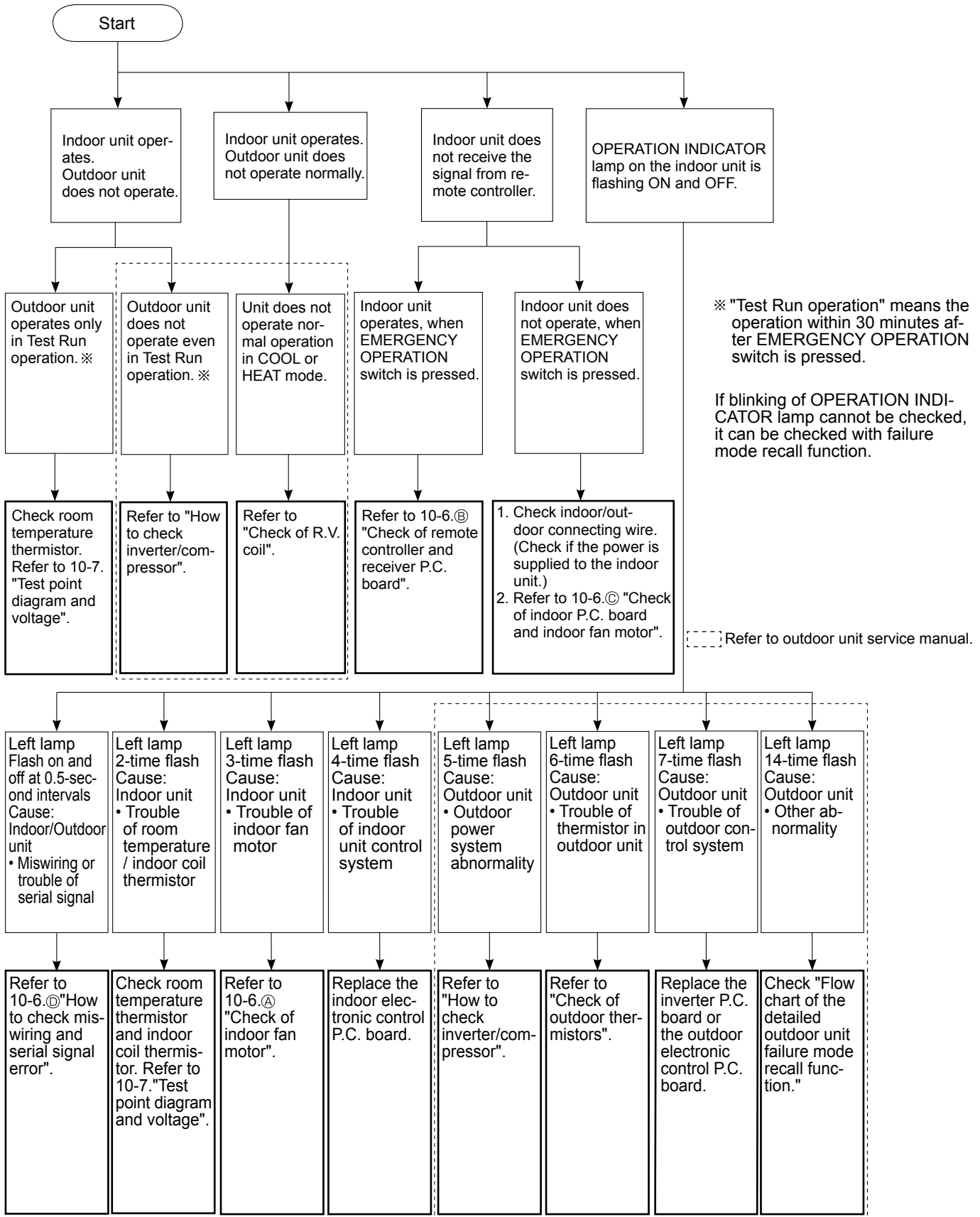

## 10-4. TROUBLESHOOTING CHECK TABLE

Before taking measures, make sure that the symptom reappears for accurate troubleshooting.

When the indoor unit has started operation and detected an abnormality of the following condition (the first detection after the power ON), the indoor fan motor turns OFF and OPERATION INDICATOR lamp flashes.

### OPERATION INDICATOR



Lighted

Blinking

Not lighted

No.	Abnormal point	Operation indicator lamp	Symptom	Condition	Correspondence
1	Miswiring or serial signal	Upper lamp flashes. 0.5-second ON  0.5-second OFF		The serial signal from the outdoor unit is not received for 6 minutes.	• Refer to 10-6. ③ "How to check miswiring and serial signal error".
2	Indoor coil thermistor Room temperature thermistor	Upper lamp flashes. 2-time flash  2.5-second OFF		The indoor coil or the room temperature thermistor is short or open circuit.	• Refer to 10-7. the characteristics of indoor coil thermistor, and the room temperature thermistor.
3	Indoor fan motor	Upper lamp flashes. 3-time flash  2.5-second OFF		The rotational frequency feedback signal is not emitted during the indoor fan operation.	• Refer to 10-6. ④ "Check of indoor fan motor".
4	Indoor control system	Upper lamp flashes. 4-time flash  2.5-second OFF	Indoor unit and outdoor unit do not operate.	It cannot properly read data in the nonvolatile memory of the indoor electronic control P.C. board.	• Replace the indoor electronic control P.C. board.
5	Outdoor power system	Upper lamp flashes. 5-time flash  2.5-second OFF		It consecutively occurs 3 times that the compressor stops for overcurrent protection or start-up failure protection within 1 minute after start-up.	• Refer to "How to check of inverter/compressor". Refer to outdoor unit service manual • Check the stop valve.
6	Outdoor thermistors	Upper lamp flashes. 6-time flash  2.5-second OFF		The outdoor thermistors short or open circuit during the compressor operation.	• Refer to "Check of outdoor thermistor". Refer to outdoor unit service manual.
7	Outdoor control system	Upper lamp flashes. 7-time flash  2.5-second OFF		It cannot properly read data in the nonvolatile memory of the inverter P.C. board or the outdoor electronic control P.C. board.	• Replace the inverter P.C. board or the outdoor electronic control P.C. board. Refer to outdoor unit service manual.
8	Other abnormality	Upper lamp flashes. 14-time flash  2.5-second OFF		An abnormality other than above mentioned is detected.	• Check the stop valve. • Confirm the abnormality in detail using the failure mode recall function for outdoor unit.
9	Outdoor control system	Upper lamp lights up	Outdoor unit does not operate	It cannot properly read data in the nonvolatile memory of the inverter P.C. board or the outdoor electronic control P.C. board.	• Check the blinking pattern of the LED on the inverter P.C. board or the outdoor electronic control P.C. board.

OPERATION INDICATOR



No.	Abnormal point	Operation indicator lamp	Symptom	Condition	Correspondence
1	MXZ type Operation mode setting	Upper lamp lights and lower lamp flashes. 	Outdoor unit operates but indoor unit does not operate.	The operation mode of the each indoor unit is differently set to COOL (includes DRY) and HEAT at the same time, the operation mode of the indoor unit that has operated at first has the priority.	<ul style="list-style-type: none"> <li>Unify the operation mode. Refer to outdoor unit service manual.</li> </ul>

10-5. TROUBLE CRITERION OF MAIN PARTS  
MSZ-SF15VA MSZ-SF20VA

Part name	Check method and criterion	Figure			
Room temperature thermistor (RT11) Indoor coil thermistor (RT12, RT13)	Measure the resistance with a tester. Refer to 10-7. "Test point diagram and voltage", "Indoor electronic control P.C. board", for the chart of thermistor.				
Indoor fan motor (MF)	Refer to 10-6.Ⓐ "Check of indoor fan motor."				
Vane motor (MV)	Measure the resistance between the terminals with a tester. (Temperature: 10 - 30°C) <table border="1" style="margin-left: 20px;"> <thead> <tr> <th>Color of the lead wire</th> <th>Normal</th> </tr> </thead> <tbody> <tr> <td>RED - YLW</td> <td>223 - 268 Ω</td> </tr> </tbody> </table>		Color of the lead wire	Normal	RED - YLW
Color of the lead wire	Normal				
RED - YLW	223 - 268 Ω				

## 10-6. TROUBLESHOOTING FLOW

### Ⓐ Check of indoor fan motor

The indoor fan motor error has occurred, and the indoor fan does not operate.

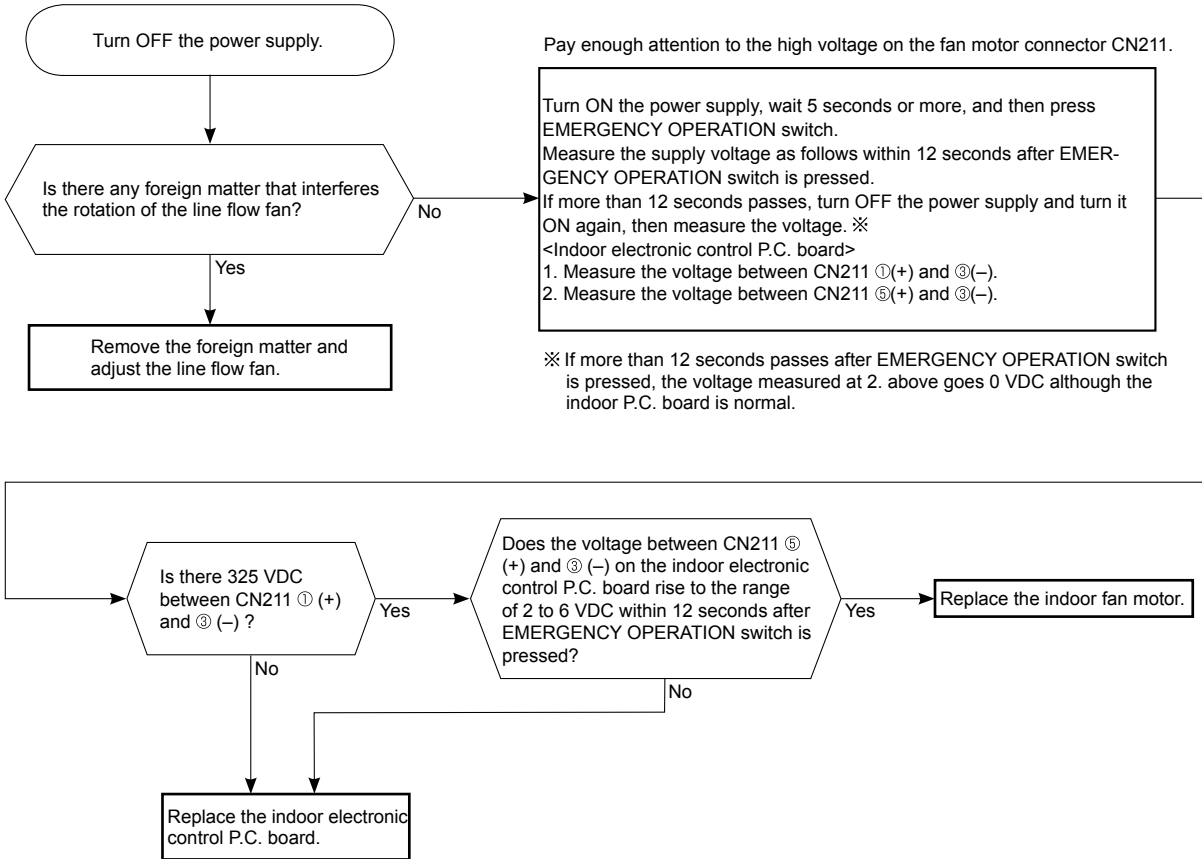

The indoor fan motor error has occurred, and the indoor fan repeats "12-second ON and 30-second OFF" 3 times, and then stops.

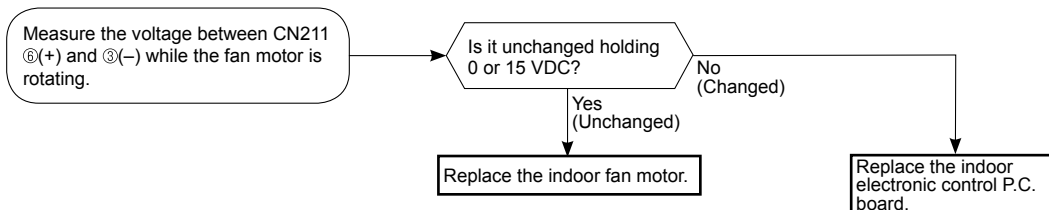

## B Check of remote controller and indoor electronic control P.C. board

※Check if the remote controller is exclusive for this air conditioner.

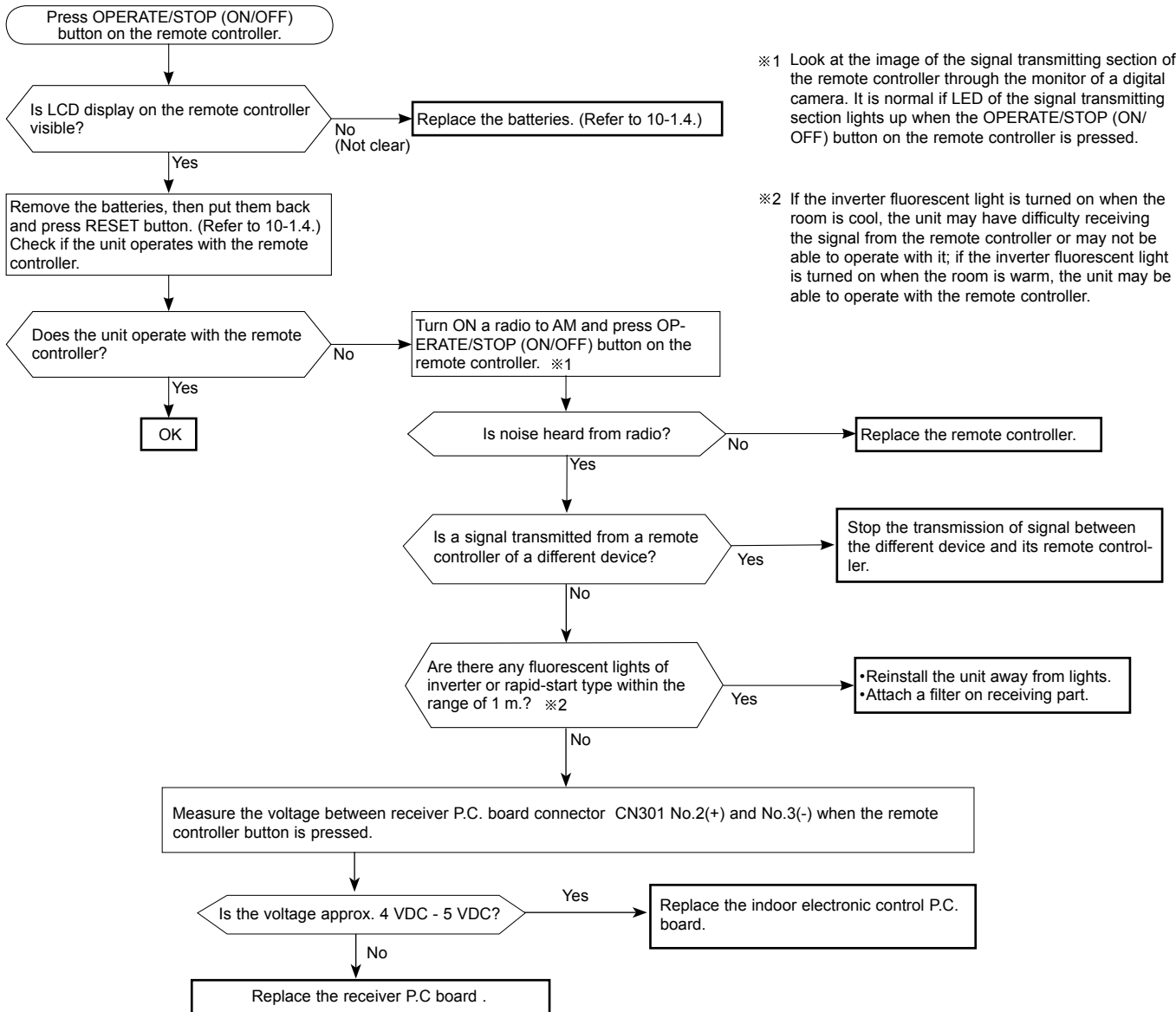



## © Check of indoor P.C. board and indoor fan motor

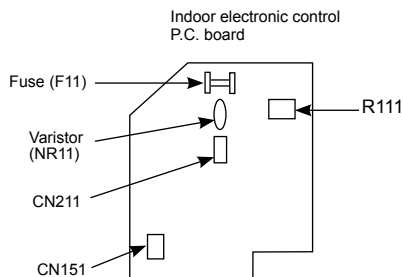
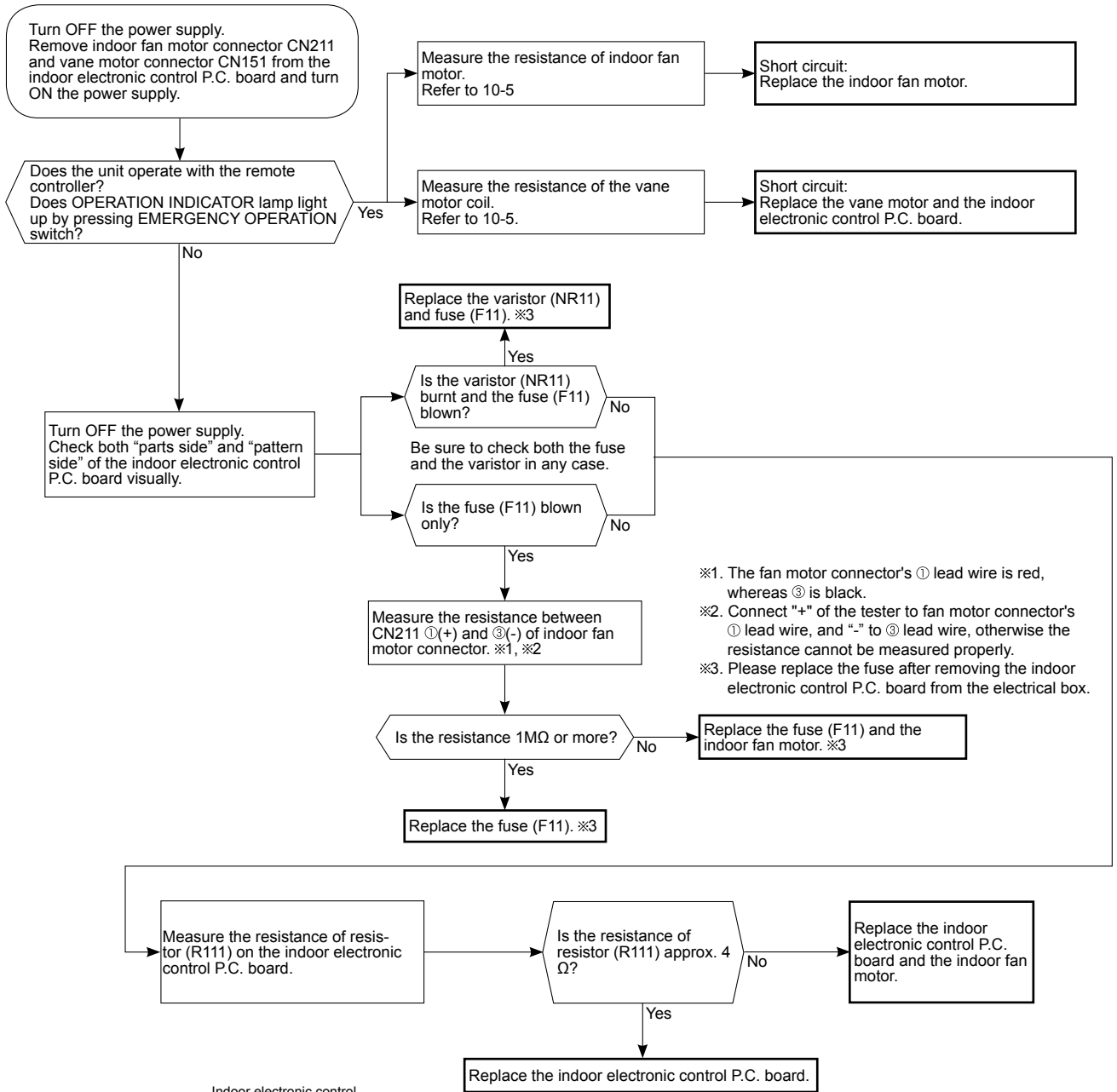

## D How to check miswiring and serial signal error



## E Electromagnetic noise enters into TV sets or radios

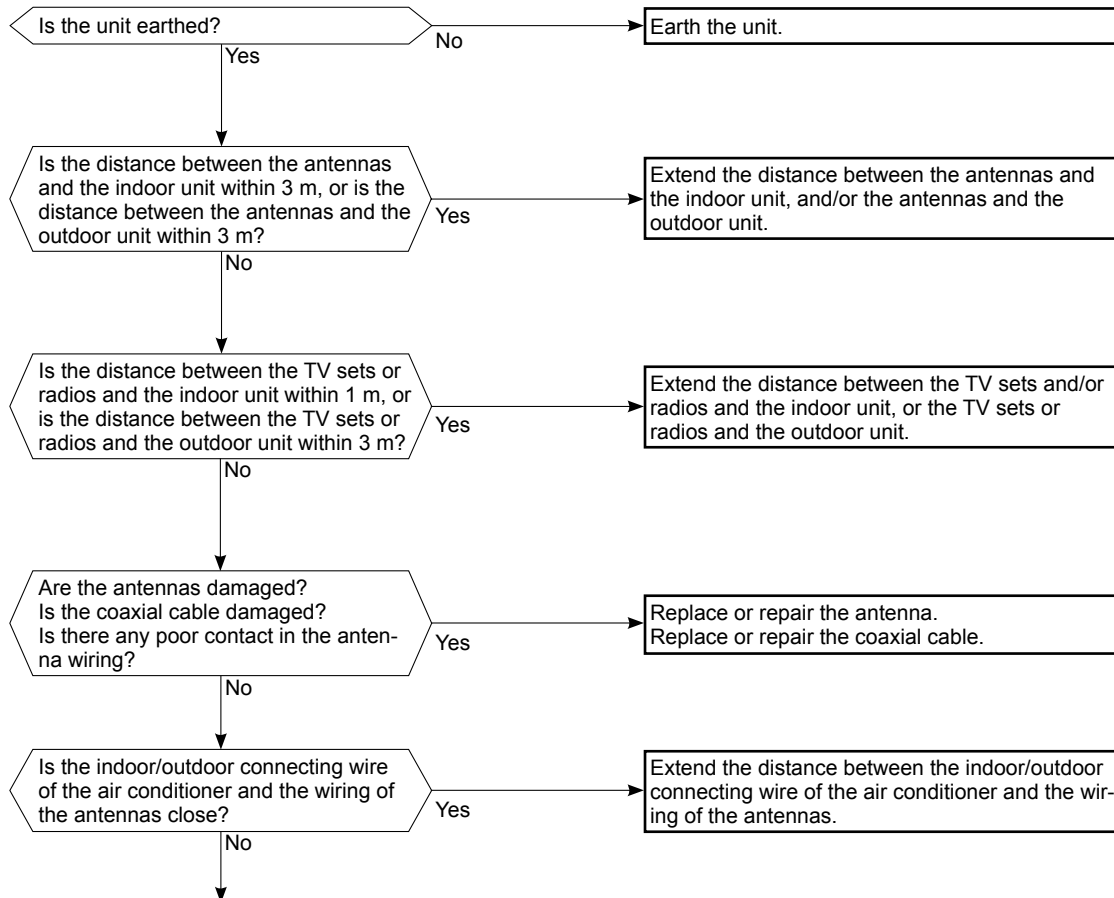

Even if all of the above conditions are fulfilled, the electromagnetic noise may enter, depending on the electric field strength or the installation condition (combination of specific conditions such as antennas or wiring).  
Check the following before asking for service.

1. Devices affected by the electromagnetic noise  
TV sets, radios (FM/AM broadcast, shortwave)
2. Channel, frequency, broadcast station affected by the electromagnetic noise
3. Channel, frequency, broadcast station unaffected by the electromagnetic noise
4. Layout of:  
indoor/outdoor unit of the air conditioner, indoor/outdoor wiring, earth wire, antennas, wiring from antennas, receiver
5. Electric field intensity of the broadcast station affected by the electromagnetic noise
6. Presence or absence of amplifier such as booster
7. Operation condition of air conditioner when the electromagnetic noise enters in
  - 1) Turn OFF the power supply once, and then turn ON the power supply. In this situation, check for the electromagnetic noise.
  - 2) Within 3 minutes after turning ON the power supply, press OPERATE/STOP (ON/OFF) button on the remote controller for power ON, and check for the electromagnetic noise.
  - 3) After a short time (3 minutes later after turning ON), the outdoor unit starts running. During operation, check for the electromagnetic noise.
  - 4) Press OPERATE/STOP (ON/OFF) button on the remote controller for power OFF, when the outdoor unit stops but the indoor/outdoor communication still runs on. In this situation, check for the electromagnetic noise.

**10-7. Test point diagram and voltage**  
**MSZ-SF15VA MSZ-SF20VA**  
**Indoor electronic control P.C. board**

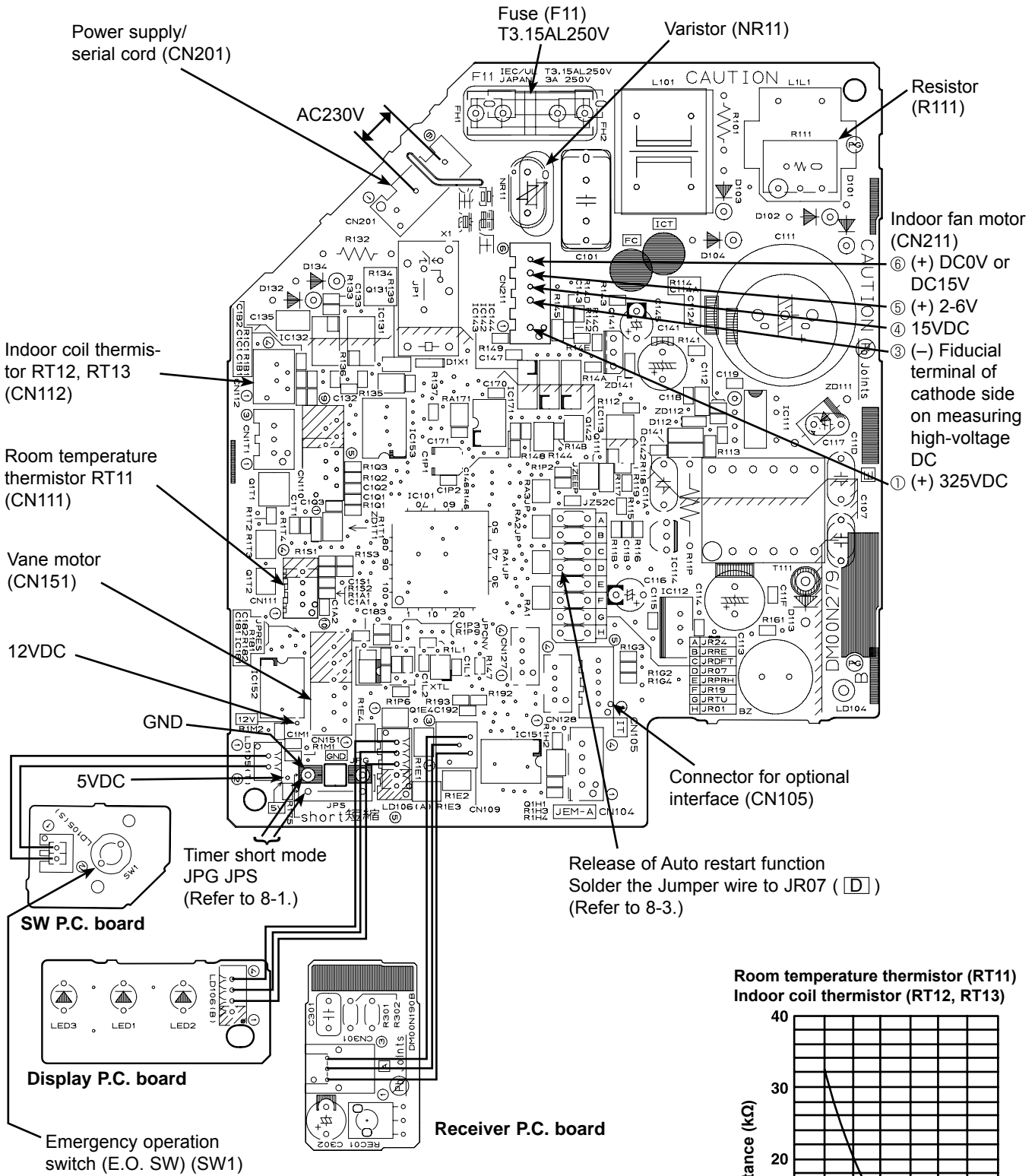

**Room temperature thermistor (RT11)**  
**Indoor coil thermistor (RT12, RT13)**

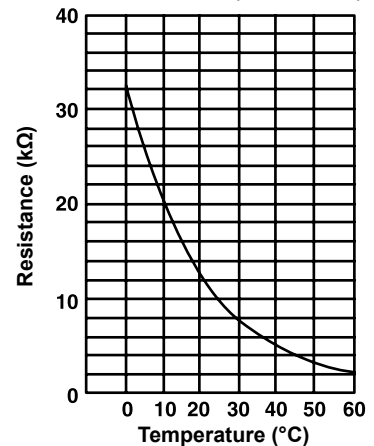

## &lt;"Terminal with locking mechanism" Detaching points&gt;

The terminal which has the locking mechanism can be detached as shown below.  
There are two types (refer to (1) and (2)) of the terminal with locking mechanism.  
The terminal without locking mechanism can be detached by pulling it out.  
Check the shape of the terminal before detaching.

(1) Slide the sleeve and check if there is a locking lever or not.

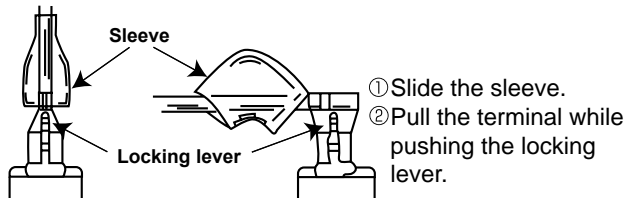

(2) The terminal with this connector has the locking mechanism.

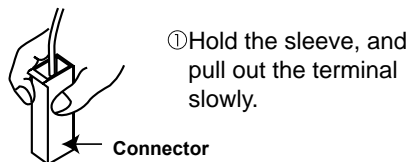
**MSZ-SF15VA MSZ-SF20VA**

**NOTE:** Turn OFF power supply before disassembling.

OPERATING PROCEDURE	PHOTOS
<p><b>1. Removing the panel</b></p> <ol style="list-style-type: none"> <li>(1) Remove the horizontal vanes.</li> <li>(2) Remove the screw caps of the panel. Remove the screws.</li> <li>(3) Unhook the lower part (A) of the panel.</li> <li>(4) Hold the lower part of both ends of the panel and pull it slightly toward you, and then remove the panel by pushing it upward.</li> </ol>	<p><b>Photo 1</b></p>

## OPERATING PROCEDURE

### 2. Removing the indoor electronic control P.C. board, receiver P.C. board, display P.C. board, and SW P.C. board

- (1) Remove the panel (refer to 1.) and the corner box.
- (2) Remove the screw of the V.A. clamp. Remove the V.A. clamp and the indoor/outdoor connecting wire. (Photo 2)
- (3) Remove the screw of the electrical cover, and then the electrical cover. (Photo 2)
- (4) Remove the display holder and SW holder. (Photo 3)
- (5) Open the rear cover of the display holder and pull out the receiver P.C. board. (Photo 5)
- (6) Open the front cover of the display holder and pull out the display P.C. board. (Photo 5)
- (7) Open the SW holder and pull out the SW P.C. board.
- (8) Disconnect the following connectors on the electronic control P.C. board:
  - CN211 (Indoor fan motor)
  - CN201 (Terminal block)
  - CN211 (Indoor coil thermistor)
  - CN151 (Horizontal vane motor)
  - CN109 (Receiver P.C. board)
- (9) Pull out the electronic control P.C. board from the electrical box.
- (10) Remove the earth wire connected to the indoor electronic control P.C. board from the electrical box. (Photo 3)

## PHOTOS

Photo 2

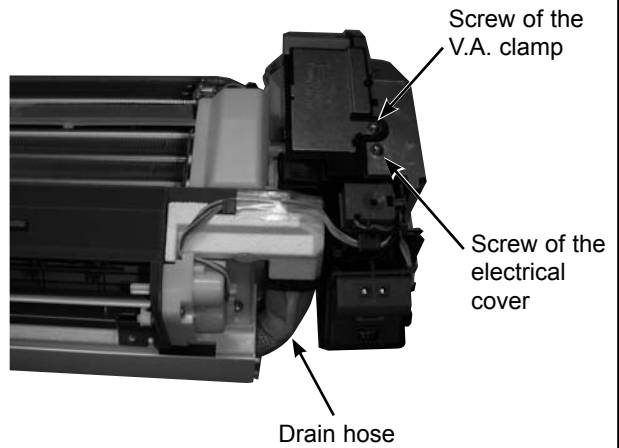

Photo 3

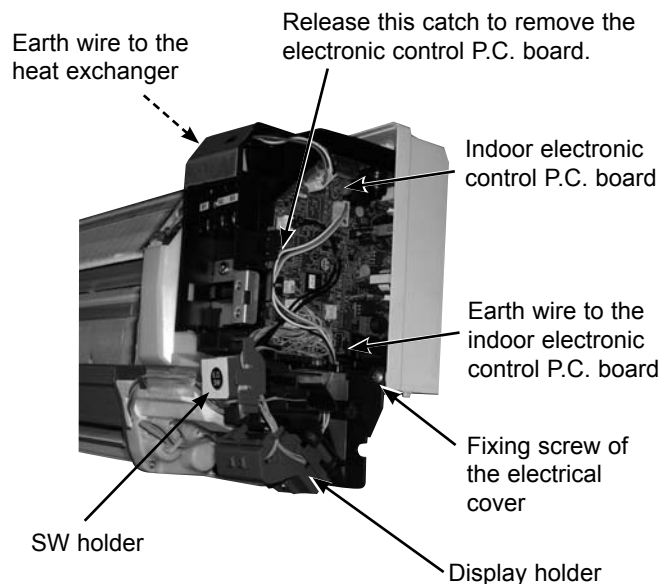
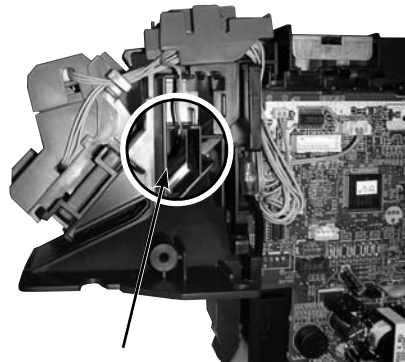

Photo 4



Room temperature thermistor (RT11)

Be sure to install this thermistor in the proper direction.



## OPERATING PROCEDURE

### 7. Removing the indoor fan motor and the line flow fan

- (1) Remove the panel (refer to 1.) and the corner box.
- (2) Remove the SW holder, the display P.C. board holder, the electrical box (refer to 3.) and the nozzle assembly (Refer to 4.).
- (4) Remove the screws fixing the motor bed. (Photo 7)
- (5) Loosen the screw fixing the line flow fan. (Photo 8)
- (6) Push the upper part of the water cover and unhook the catch.
- (7) Pull the water cover to the right to remove it.
- (8) Remove the motor bed together with fan motor and motor band.
- (9) Release the hooks of the motor band. Remove the motor band. Pull out the indoor fan motor.
- (10) Remove the screws fixing the left side of the heat exchanger. (Photo 12)
- (11) Lift the heat exchanger, and pull out the line flow fan to the lower-left.

## PHOTOS

Photo 7

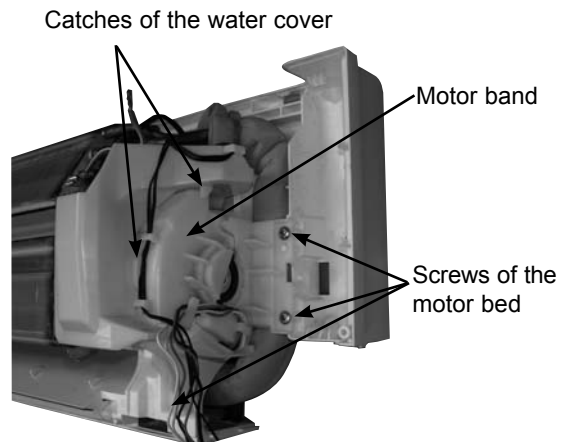

Photo 8

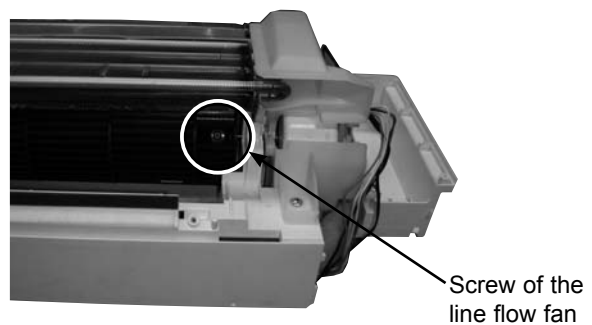
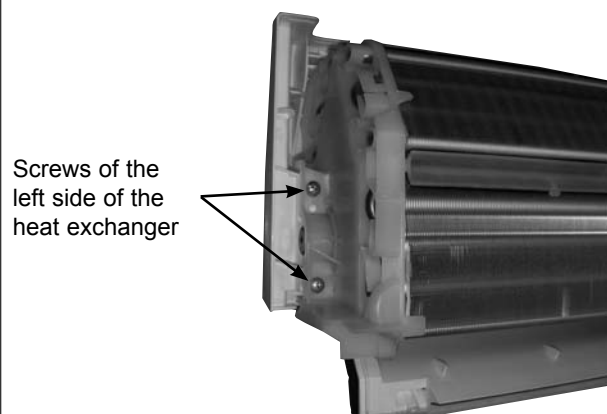

Photo 9



 **MITSUBISHI ELECTRIC CORPORATION**

HEAD OFFICE: TOKYO BLDG., 2-7-3, MARUNOUCHI, CHIYODA-KU, TOKYO 100-8310, JAPAN